



Dependable Products From People You Trust



Static Gel Strength Measurement Device

Patent No. 9,612,232 - OFI Testing Equipment, Inc.

#120-53 - Low Pressure, 5,000 PSI
#120-58 - High Pressure, 20,000 PSI

Instruction Manual

Updated 1/31/2025
Ver. 10

OFI Testing Equipment, Inc.
11302 Steeplecrest Dr. · Houston, Texas · 77065 · U.S.A.
Tele: 832.320.7300 · Fax: 713.880.9886 · www.ofite.com

©Copyright OFITE 2015

Table of Contents

Intro	2
Description	2
Features	2
Specifications	3
Components	3
Safety	5
Quick Start	6
Setup	7
<i>Hardware</i>	<i>7</i>
<i>Software</i>	<i>8</i>
Software	10
<i>Temperature Profile Builder</i>	<i>14</i>
<i>Operation</i>	<i>15</i>
<i>Calibration Archives</i>	<i>17</i>
Operation	19
<i>Cell Cap Assembly</i>	<i>19</i>
<i>SGSM Drag Check</i>	<i>27</i>
<i>Preparing the Test Cell</i>	<i>28</i>
<i>Connecting the Cell</i>	<i>29</i>
<i>Starting the Test</i>	<i>31</i>
<i>Stopping the Test</i>	<i>32</i>
<i>Evaluating Test Data</i>	<i>33</i>
<i>Removing the Test Cell</i>	<i>34</i>
Maintenance	35
<i>Disassembling and Cleaning the Test Cell</i>	<i>35</i>
<i>Changing a Fuse</i>	<i>41</i>
Appendix	42
<i>Filling The Cell</i>	<i>42</i>
<i>Magnet Positioning</i>	<i>43</i>
<i>Calibration - Old Style</i>	<i>44</i>
<i>SGSM Cell Cap Assembly</i>	<i>45</i>
<i>Calibration - New Style</i>	<i>49</i>
<i>Maintenance Schedule</i>	<i>51</i>
<i>Multiple Instruments</i>	<i>52</i>
<i>Manual Temperature Control</i>	<i>53</i>
<i>Electrical System Grounding</i>	<i>56</i>
<i>Troubleshooting</i>	<i>57</i>
<i>Diagrams - Drive Assembly</i>	<i>58</i>
<i>Diagrams - High Pressure Cell Assembly</i>	<i>59</i>
<i>Diagrams - Low Pressure Cell Assembly</i>	<i>60</i>
Warranty and Return Policy	61

Intro

The Static Gel Strength Measurement (SGSM) device uses a vaned bob to condition a cement slurry inside a pressurized test cell and measure static gel strength at down-hole conditions. By directly measuring the forces required to initiate movement in the sample, the SGSM provides an accurate way of determining the static gel strength.

Description

The High Pressure SGSM (#120-58) fits in a high-pressure UCA test cell. This configuration is compatible with both the Single Cell UCA (#120-50) and the Dual Cell UCA (#120-52).

The Low Pressure SGSM (#120-53) fits in a low-pressure UCA test cell. This configuration is compatible with the Twin Cell UCA (#120-51).

In an SGSM test, a vaned bob is submerged in the cement. During the test, the bob turns periodically and measures the static gel strength of the sample.

A computer running OFITE software graphs the data from both cells. This data is available in real time on-screen and is also stored in an Excel® spreadsheet for easy graphical viewing and printing.

Features

- Mechanical measurement of static gel strength
- Conditions the cement in the test cell
- Data is available instantly on-screen and is automatically converted to Excel® spreadsheet format

Specifications

Size:

- High Pressure SGSM (with cell): 20" tall × 6" diameter (51 × 15 cm)
- Low Pressure SGSM (with cell): 18.25" tall × 6" diameter (46 × 15 cm)
- SGSM Electronics Box: 8" × 3" × 10" (20 × 8 × 25 cm)

Weight:

- High Pressure SGSM (with cell): 49.4 lb (22.4 kg)
- Low Pressure SGSM (with cell): 46 lb (20.1 kg)
- SGSM Electronics Box: 1.2 lb (544 g)

Equipment:

- The High Pressure SGSM (#120-58) requires either a Single Cell UCA (#120-50) or a Dual Cell UCA (#120-52)
- The Low Pressure SGSM (#120-53) requires a Twin Cell UCA (#120-51)

Power Requirements:

- 100 - 240 Volt, 50–60 Hz, 2 Amp, Fuse: T 2.0A L 250V

Computer:

- Windows XP or higher
- RS-232 Serial Port (or Serial to USB Adapter)
- Minimum Screen Resolution: 1280 × 680

Environmental Conditions:

- For indoor use only
- Maximum Altitude: 6,562 ft (2,000 m)
- Temperature: 41° - 104°F (5°–40°C)
- Maximum Relative Humidity: 80% for temperatures up to 88°F (31°C) decreasing linearly to 50% at 104°F (40°C)

Components

Only use replacement parts that have been supplied by OFITE

#120-53-25	LPT Cable
#120-53-80	Electronics Box
#120-53-81	Wrench, Combination, $\frac{3}{16}$ "
#120-58-005	Drive Assembly (See diagram on page 58 for parts list)
#120-58-07	Wrench, Allen, $\frac{5}{64}$ "
#120-58-08	Calibration Stand
#120-58-16	Wrench, Strap, 5"
#120-75-9	Weight Hanger
#120-75-10	Weight Set
#122-073	Fuse, 2 Amp, 5 mm × 20 mm
#122-075-1	Fuse, 8 Amp, 5 mm × 20 mm
#130-79-15	Serial Cable
#152-37	Power Cord, 115 Volt, USA,
#220-10A-EURO	Power Cable, European
#220-15A-USA	Power Cable, USA

High Pressure SGSM:

#120-50-018	Fill Gauge
#120-209	Thermocouple Assembly
#120-58-006	High Pressure Cell Assembly (See diagram on page 59 for parts list)

Low Pressure SGSM:

- #120-51-020 Thermocouple Assembly
- #120-53-006 Low Pressure Cell Assembly (See diagram on page 60 for parts list)
- #120-51-021 Fill Gauge







Optional:**#120-53-SP Spare Parts Kit for Low Pressure SGSM:**

- #120-50-026 Retaining Ring, Qty: 2
- #120-50-027-1 Seal Ring, Qty: 2
- #120-53-01 Vane Assembly, Qty: 1
- #120-53-010 Mag Shaft, Qty: 1
- #120-53-041 Bearing, Qty: 1
- #120-53-23 Diaphragm, Qty: 1
- #120-53-31 O-ring, Qty: 5
- #120-53-32 O-ring, Qty: 5
- #120-53-33 Tension Spring, Qty: 1
- #120-53-38 Retaining Ring, Internal, Qty: 2
- #120-53-42 Bushing Graphite, Qty: 10
- #120-53-43 Filter, Qty: 1
- #120-53-58 Backup Ring, Upper, Qty: 2
- #120-53-59 Backup Ring, Lower, Qty: 2
- #120-53-82 Retaining Ring, Qty: 2
- #120-58-05 Retaining Ring, External, Qty: 2
- #123-011 O-ring for Test Cell, Qty: 5

#120-58-SP Spare Parts Kit for High Pressure SGSM:

- #120-50-026 Retaining Ring, External, Qty: 2
- #120-50-027-1 Seal Ring, Qty: 2
- #120-53-01 Vane Assembly, Qty: 1
- #120-53-041 Bearing, Qty: 1
- #120-53-31 O-ring, Qty: 5
- #120-53-32 O-ring, Qty: 5
- #120-53-33 Tension Spring, Qty: 1
- #120-53-42 Bushing, Graphite, Qty: 10
- #120-53-58 Backup Ring, Upper, Qty: 2
- #120-53-59 Backup Ring, Lower, Qty: 2
- #120-53-82 Retaining Ring, External, Qty: 2
- #120-58-010 Mag Shaft, Qty: 1
- #120-58-05 Retaining Ring, External, Qty: 2
- #120-58-23 Diaphragm, Qty: 1
- #120-58-38 Retaining Ring, Internal, Qty: 2
- #122-073 Fuse, 2 Amp, 5 mm × 20 mm, Qty: 2
- #123-011 O-ring for Test Cell, Qty: 5

Safety

Explanation of Symbols	
	Caution: Risk of Danger - This symbol directs the operator to consult the instruction manual for safety related warnings. (ISO-7000-0434) Whenever this symbol is used on the equipment, the user must consult the manual to determine the nature of the hazard and any actions which have to be taken.
	Hot: This symbol indicates that a surface may be hot to the touch.
	Shock Hazard: This symbol indicates a risk of electrical shock.
 Note	Note: This symbol will indicate important notes and helpful hints for the operation of the equipment.
 Tip	Tip: This symbol is used to identify operational information and best practices to obtain the most reliable data.
	Caution: Note - This symbol is used to indicate statements in the manual which warn against actions which may cause damage to the equipment during routine service or maintenance.

Quick Start

1. Set up the software with the desired parameters (see page 8).
2. Prepare the cell caps and cell body.
3. Assemble the bottom cell cap. See page 19.
4. Install the bottom cell cap to the bottom of the cell body. See page 20.
5. Assemble the top cell cap. See page 21.
6. Assemble the SGSM shaft assembly and install it to the top cell cap. See page 24.
7. Install the top cell cap to the cell assembly.
8. Install the test cell to the cabinet.
9. Connect the SGSM head to the shaft assembly and run a drag check. See page 27.
10. Mix the slurry and fill the cell. See page 28.
11. Connect water supply line, thermocouple, and transducer to the test cell. See page 29.
12. Run the test. See page 31.
13. Allow test cell to cool down. See page 34.
14. Evaluate the test data. See page 33.
15. Remove test cell.
16. Disassemble and clean the cement from the test cell. See page 35.
17. Clean and inspect all of the test cell components.

Setup Hardware



1. Carefully remove the instrument from the crate and place it on a flat, stable surface. Make sure to allow for adequate air flow around the unit, especially near the vents on the sides.

To ensure personal safety, always use proper lifting techniques. Position the unit so that the user can quickly disconnect plugs in case of an emergency.

2. Connect the equipment to the computer. Each test configuration requires a different set of connections to the computer.

- **Single UCA or Dual UCA** - Connect the UCA to a PC with the supplied serial cable.
- **Single SGSM or UCA/SGSM** - Connect the PC and the UCA unit to the SGSM Data Hub with the supplied serial cables. Connect the SGSM to the Data Hub with the supplied LPT cable.

When using only the UCA/SGSM software on a dual cell instrument, always connect the SGSM to Cell 2.

When using the Single UCA or Single SGSM software with a Dual Cell or Twin Cell UCA, always run the test on Cell 1.

- **Dual SGSM** - Each SGSM has a Data Hub. Connect each SGSM to its Data Hub using the supplied LPT cables. Connect the first Data Hub to the UCA unit using a serial cable. Connect both Data Hubs to the computer with serial cables.

Make sure all SGSM electrical connections have been made before attempting to turn on the SGSM box as this may cause damage to internal electrical components.

3. Turn the "Main Power" switch on once fully connected to the UCA and PC.

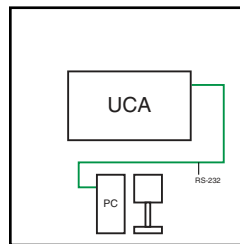

Single UCA or Dual UCA

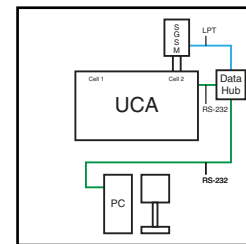

UCA/SGSM

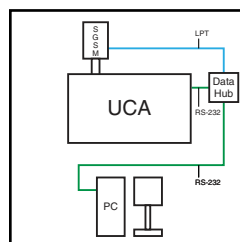

Single SGSM

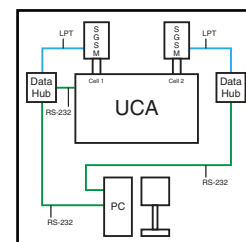

Dual SGSM

Setup

Software

Before you begin your test, you must prepare the PC to record the data. Five software applications have been included with your instrument:

- **Single SGSM** - For running an SGSM test on a Single-Cell UCA
- **UCA and SGSM** - For running a UCA and SGSM on a Dual-Cell UCA
- **Dual SGSM** - For running two SGSM tests on a Dual-Cell UCA

1. Turn on the PC, UCA, and SGSM Electronics Box.
2. Open the software by double-clicking the icon on the desktop.
3. Click Utilities → Setup.

“**COM Port**” - The COM port the device is connected to. The Dual SGSM software will ask for two COM ports.

“**Temp Unit**” - °F or °C

“**Pressure**” - PSI or MPa

The pressure reading is only on the High Pressure 20,000 PSI SGSM units (#120-58).

“**Gel Strength**” - Gel strength units (Dyne/cm², lb/100 ft², Pa., lb/ft²)

“**Unit #**” - Identifies the unit generating the graph. This field is helpful when multiple units are generating graphs.

“**Archive Path**” - The location to save the data files

“**Logo Path**” - Select a logo (.JPG format) to print on the graph at the end of the test.

“**Bob Height**” - The height of the bob in millimeters

“**Bob Diameter**” - The diameter of the bob in millimeters



Note



Tip

“Conditioning Speed” - The speed (RPM) for conditioning the cement slurry prior to the SGSM test.

The recommended conditioning speed is 30 RPM. This is equivalent (based on surface area) to conditioning at 150 RPM in a pressurized consistometer.

“Conditioning Time” - This is the amount of time the SGSM will condition the cement before it begins measuring gel strength. This value must be at least 2 minutes in order to give the SGSM time to establish a zero offset.

After the Conditioning Time, the SGSM will periodically measure gel strength based on the “Test Speed”, “Test Time”, and “Wait Time” fields.

“Test Speed” - The speed (RPM) the bob will turn to break the gel and measure the gel strength of the cement.

“Test Time” - The amount of time the bob will turn while measuring gel strength.

“Wait Time” - The amount of time the bob will pause between gel strength measurement periods.

“Strength #1”, “Strength #2”, ... “Strength #5” - Enter a gel strength value in each of these fields. When the cement reaches that gel strength, the software will record the elapsed time and print it on the graph.

“Print to Printer” - When this option is on, a graph of the test results will automatically print to the printer when a test is complete.

The screenshot shows a 'Setup' dialog box with the following fields and values:

Com Port	Temp Unit	Pressure Unit	Gel Strength	Unit #
COM1	°F	psi	lb/100ft ²	1
Archive Path C:\SGSM Data				
Logo Path				
Bob Height	Bob Diameter			
41.23 mm	51.31 mm			
Conditioning Speed	Conditioning Time	Test Speed	Test Time	Wait Time
30.00	00:25:00	0.01	00:01:00	00:10:00
Strength #1	Strength #2	Strength #3	Strength #4	Strength #5
100	200	300	400	500
<input type="checkbox"/> PRINT TO PRINTER				
				OK Cancel

Software

Each software application has a set of tabs that are specific to the test configuration (Single SGSM, Dual SGSM, or UCA/SGSM).

The **SGSM Info** (single) or **Cell 1 Info/Cell 2 Info** (dual) tabs show the current SGSM test configuration and a graph of the temperature profile.

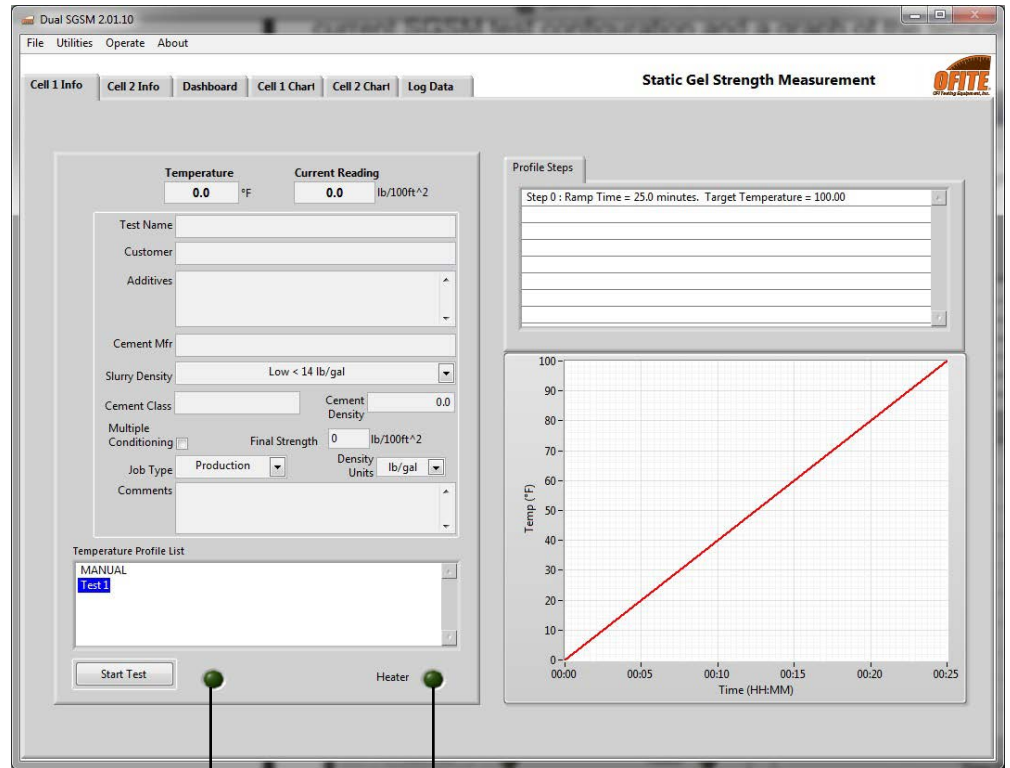

Test Started Heater Engaged



Note

The heater light only turns on when the temperature of a test is being controlled by the software. If a test is being run manually by the Eurotherm, then the heater indicator will not turn on.

The **SGSM Chart** shows a graph for an SGSM test while the test is running.

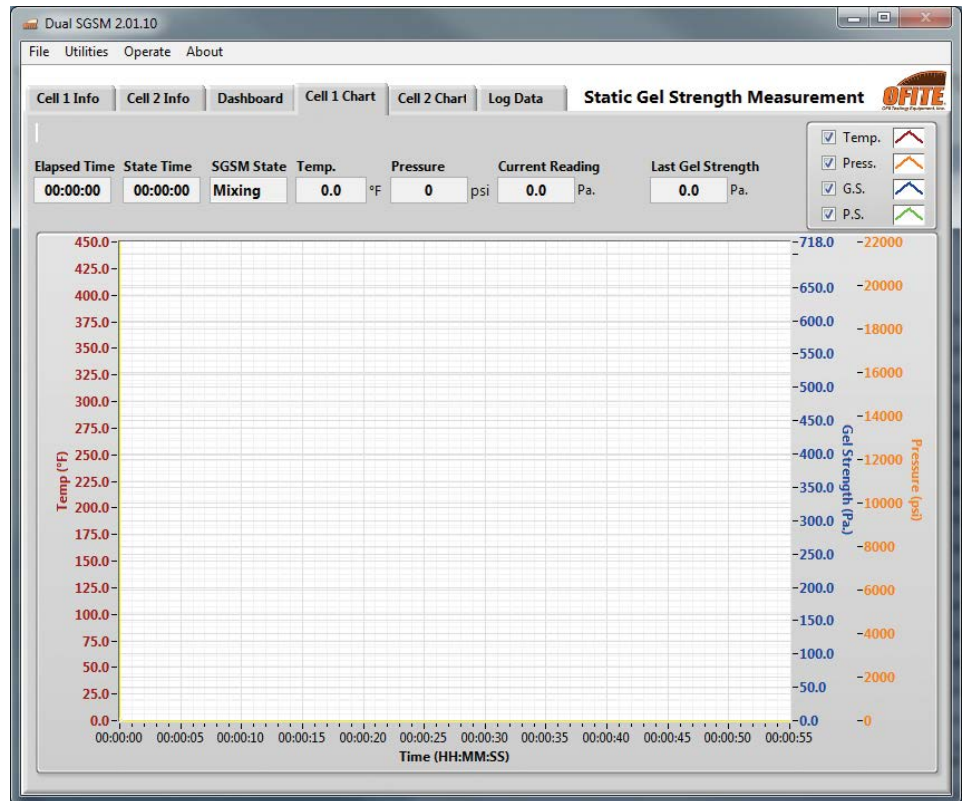

“Elapsed Time” - Time since the test began (HR:MM:SS)

“State Time” - Elapsed time of the current state.

“SGSM State” - The current state of the SGSM test.

Mixing - The bob is mixing the cement. The speed is set by the “Conditioning Speed” field in the Setup screen.

Wait - After conditioning the cement, the motor stops for 6 seconds to allow the fluid to reach a steady state.

Pre Zero - Before performing the zero operation, the software turns the bob one full revolution to overcome any initial drag.

Zero - Before starting the test, the software turns the bob one full revolution and records the amount of drag in the system. It uses these values to compensate for the drag during a test.

Stop - The bob is stopped between measurements. The bob will be stopped for the amount of time specified in the “SGSM Wait Time” field on the Setup screen.

Measure - The bob is turning and measuring gel strength. The measurement will last for the amount of time specified in "SGSM Test Time" on the Setup screen.

"Temperature" - Temperature within the test cell. (°F or °C, depending on the settings in the Setup screen)

"Pressure" - Pressure within the test cell. (PSI or MPa, depending on the settings in the Setup screen)

The pressure reading is only on the High Pressure 20,000 PSI SGSM units (#120-58).

"Current Reading" - The current gel strength measurement. This field will show the current gel strength if the SGSM State is in "Measure" or in "Stop". (Units depend on the settings in the Setup screen.)

"Last Gel Strength" - The last calculated gel strength of the sample. (Units depend on the settings in the Setup screen.)



Note

The **Dashboard** shows graphs for both cells along with current test data. Dual cell units only.

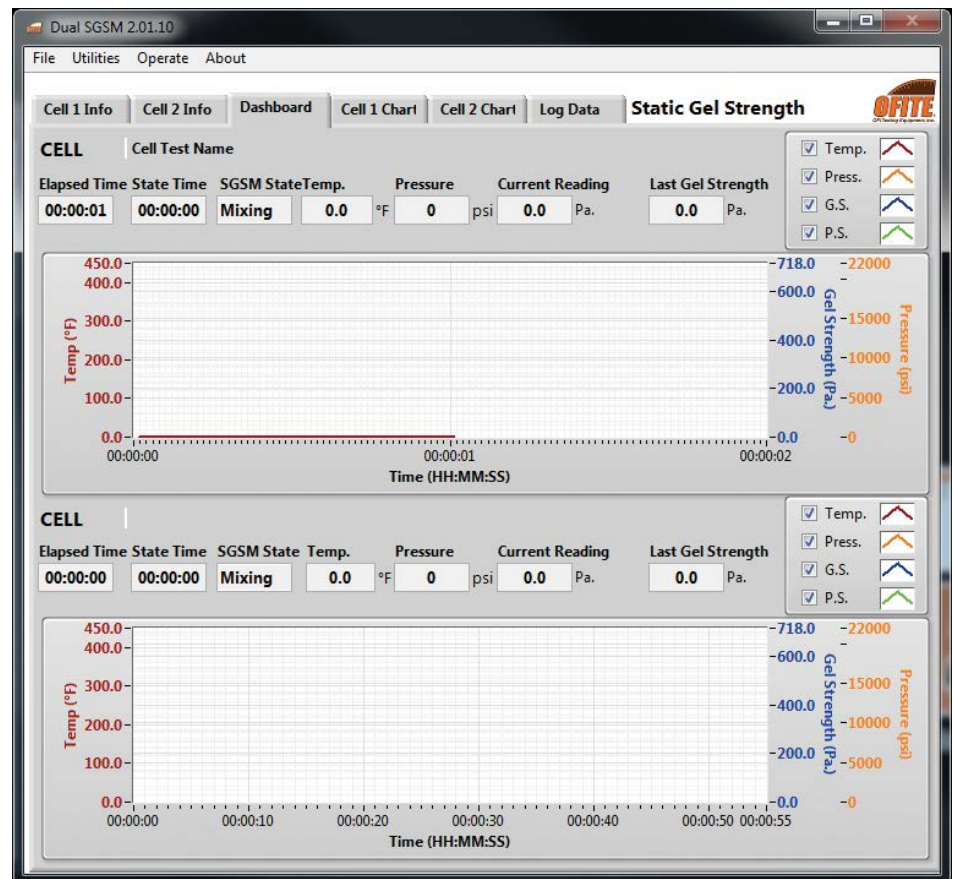

All charts in the UCA and SGSM software can be manually scaled to show more or less detail. To manually scale a chart:

1. Right-click on the X or Y axis and uncheck “AutoScale X” or “AutoScale Y”.
2. Double-click the minimum value on the axis. Type in a new value.
3. Double-click the maximum value on the axis. Type in a new value.
4. The chart will now only display values between the new minimum and maximum.

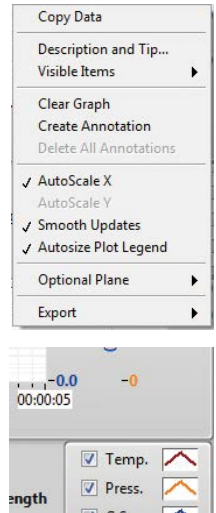

The **Log Data** tab shows the logged data for both cells.

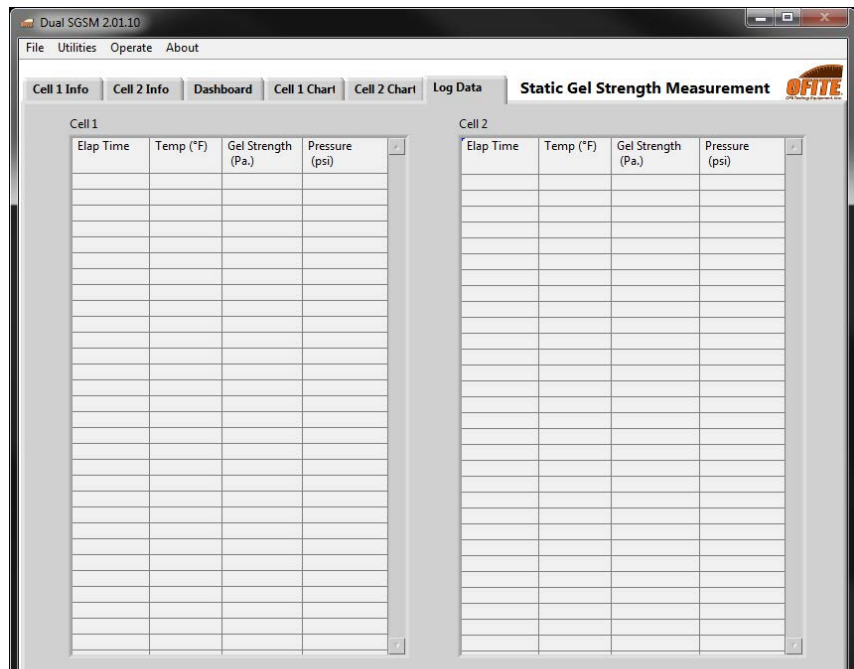

Software

Temperature Profile Builder

The SGSM Software includes a Temperature Profile Builder. Here a custom temperature profile can be created for a test.

If preferred, a temperature profile can be built manually using the Eurotherm controls. Select “MANUAL” from the “Temperature Profile List” on the Cell Info tab. Refer to page 53 for instructions on programming the Eurotherm.

1. Select “Temperatures Profile Builder” from the “Utilities” menu.
2. Either select a test to edit from the list on the left-hand side of the screen, or click “New Test” to build a new test.
3. Enter a test name.
4. Click the “Add” button to add a step. As you add steps, the graph below will change to reflect the new profile. There are three Step Types:
 - a. **Hold** - This will hold the current temperature for a set number of minutes. You will be prompted for the hold time.
 - b. **Ramp** - This will increase the temperature up to the target in a set number of minutes. You will be prompted for the ramp time and target temperature.
 - c. **Step** - This will increase the temperature up to the target as fast as possible. You will be prompted for the target temperature.
5. To edit an existing step, double click the step in the step list. Click OK when done.

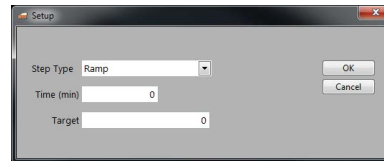

6. Click the “OK” button to exit the Temperature Profile Builder. The new Temperature Profile will now appear in the “Temperature Profile List” in the “Cell 1 Info” tab.

To setup the ramp temperature, double click on the Temperature box to open the window below. Edit the fields as needed and click “OK”.

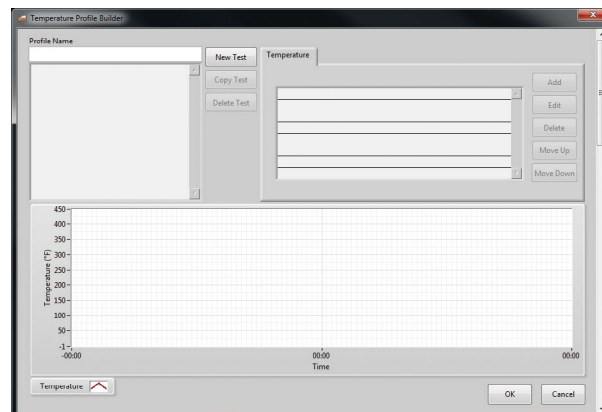

Software Operation

Once the temperature profile is built, select Operate → Load SGSM 1 Info/ Load SGSM 2 Info. Here you can enter all the necessary test information in advance, before preparing the cement sample.

Most of these fields are optional. The information in them will display in the data file at the end of the test. Select the desired profile before the test.

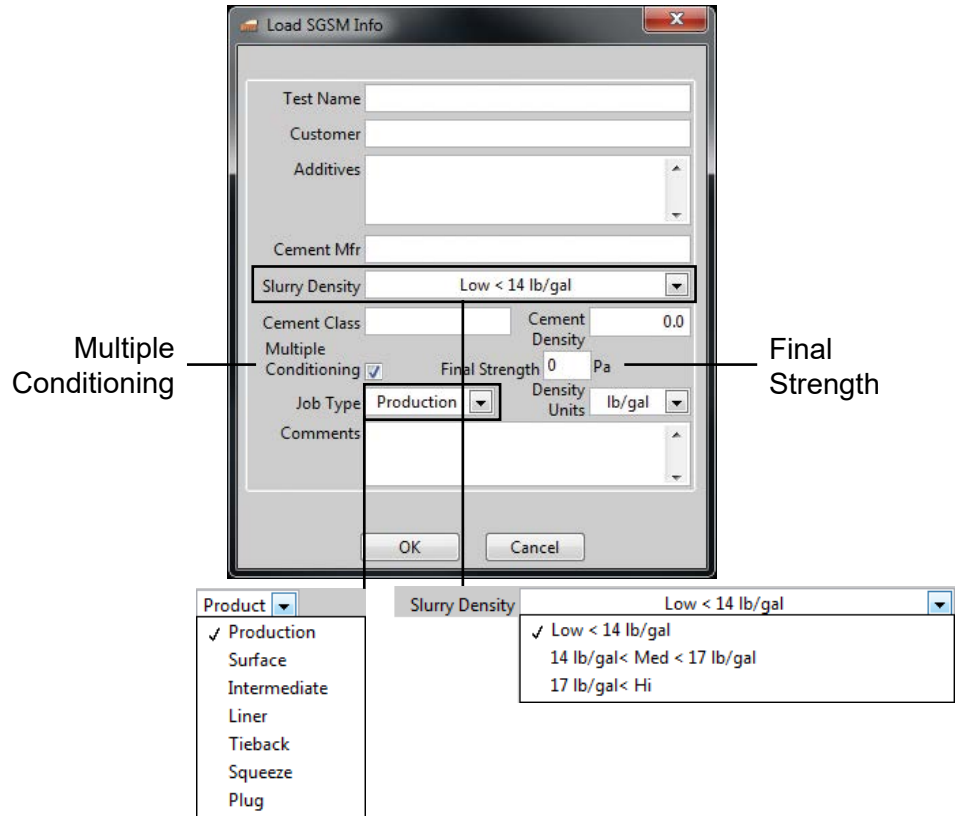

The following fields are required:

Test Name - Each test must have a unique test name. The software uses this field to name the data file.

Slurry Density - Slurry density can be entered but it will not be calculated unless it is a UCA test.

Cement Density - Cement density can be entered but it will not be calculated unless it is a UCA test.

Multiple Conditioning - When this option is turned **ON**, the software will measure gel strength periodically until the cement reaches the value in the “Strength #5” field entered in the setup screen. Then it will condition the cement for the time period specified in the “Conditioning Time” field on the Main Setup screen. This cycle will continue until the gel strength reaches the value in the “Final Strength” field on the Test Info Setup screen. Once the gel strength reaches the “Final Strength”, the alarm will sound and the test will end.



Note

This value is used for all conditioning periods when “Multiple Conditioning” is on. If no value is specified, the default is 30 minutes.

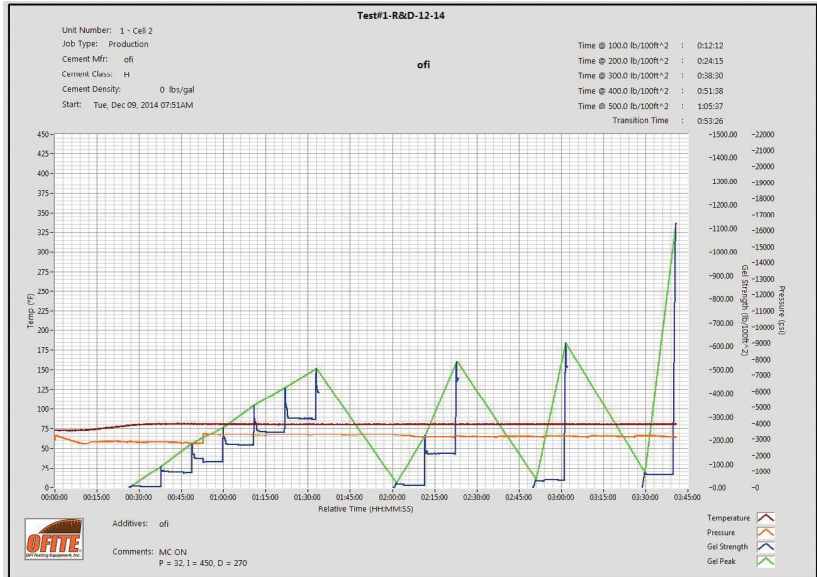

Multiple Conditioning Turned ON



Note

When Multiple Conditioning function is checked **OFF**, “Gel Strength 5”, will prompt the software to record the value, turn on the alarm, and stop the test.

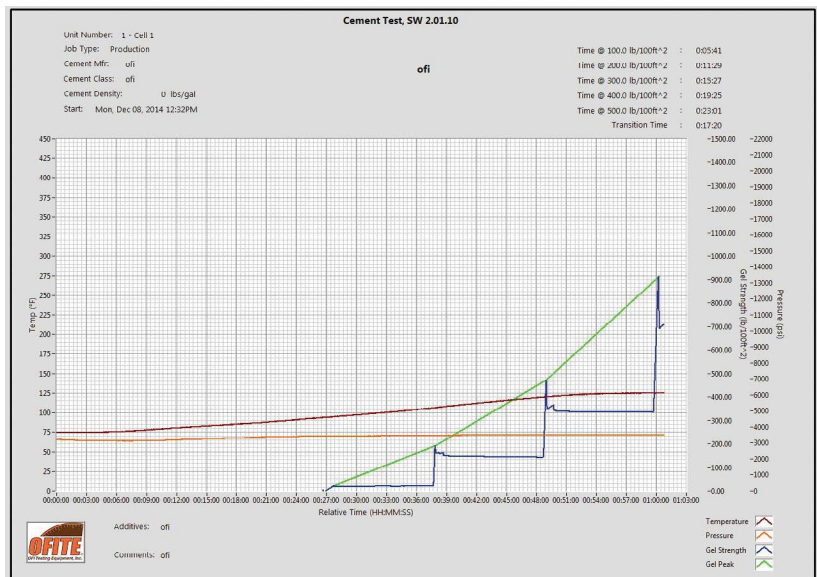

Multiple Conditioning Turned OFF

Software Calibration Archives

The SGSM software stores all calibration data from prior calibrations. To view data from a previous calibration, select “Load Cell Calibration Archive” from the “Utilities” menu. A list of previous calibrations will appear in a window to the left. Click on a calibration record and export to view the data.

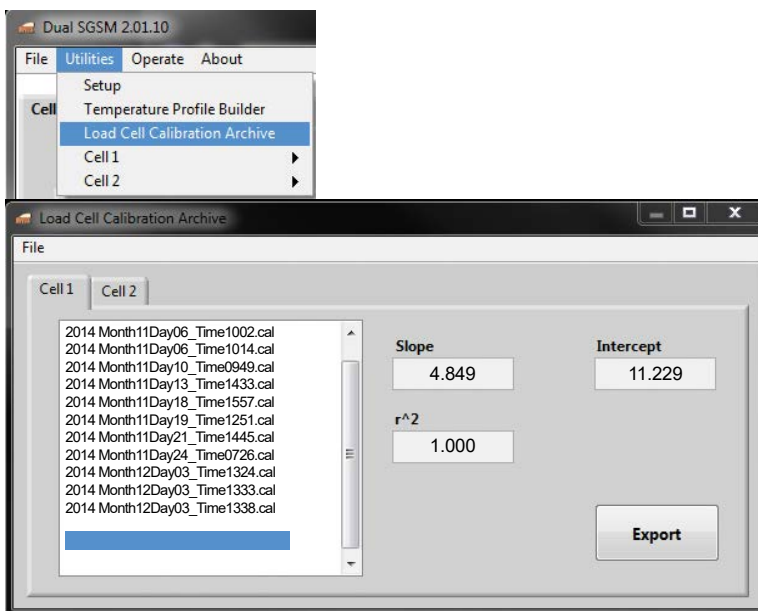

From this screen you can view and export the data to the PC in an Excel document. Select a calibration and click Export. A “Choose or Enter Path of File” window will open. Enter a file name and save it as a “.dat” document. The “.dat” document will create a text file which will allow the user to open it with text file or as an Excel file.

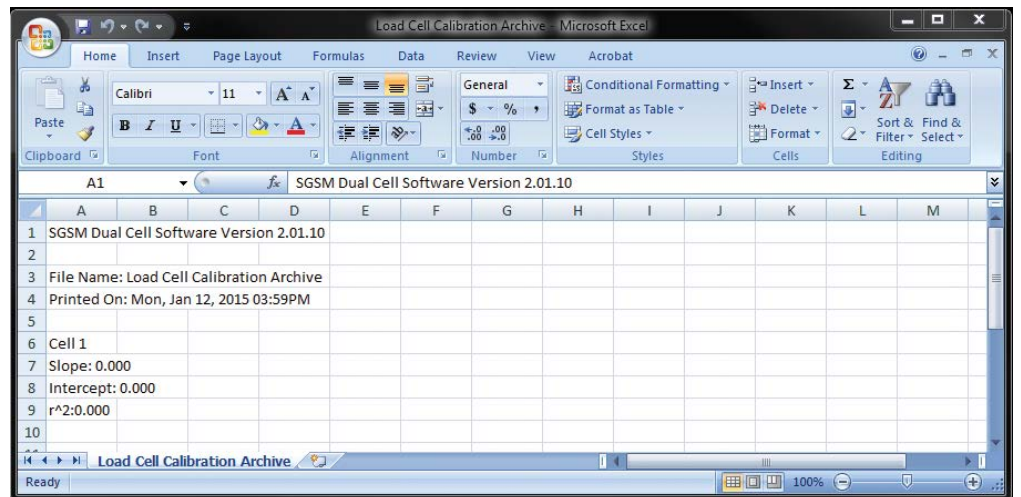
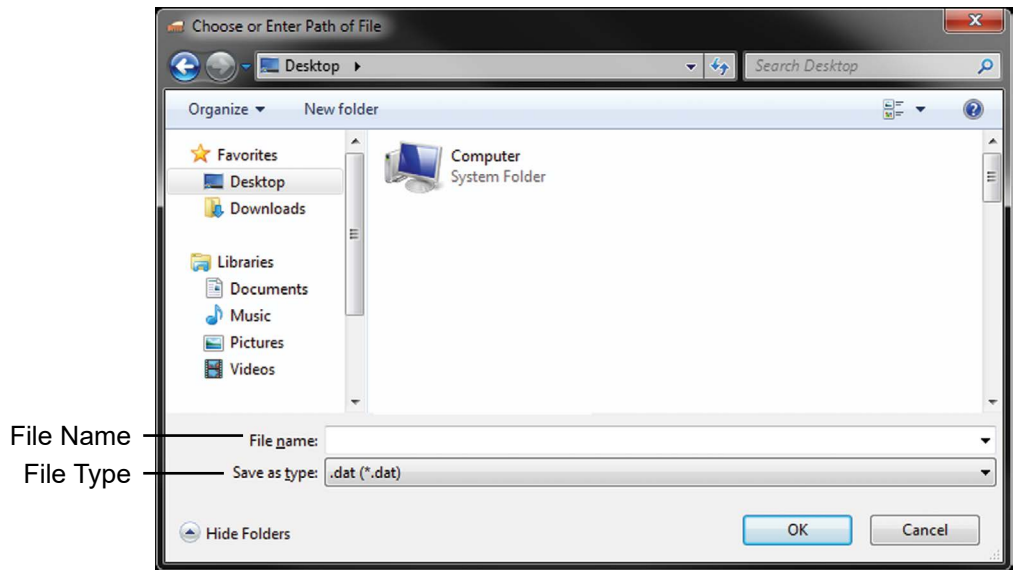

Operation

Cell Cap Assembly

The cell body and both cell caps were manufactured and pressure tested together. All three pieces are serialized. Before assembling the test cell, make sure all three pieces have the same serial number.

For a complete diagram of the test cell, refer to pages 59 and 60.

Bottom Cap Assembly

1. Inspect the transducer port to make sure that it is clean and free of debris. Dried transducer couplant can accumulate on the sides and bottom of the port. This couplant must be cleaned from the port as well.
2. Tighten the jaws of the vice on the flats of the cell cap with the threads facing up.
3. Apply a thin layer of high-temperature grease to the surface of the bottom cell cap that meets with the cement. Wipe off any excess grease.
4. For the High Pressure SGSM, install the seal ring (#120-50-027-1) with the narrow side pointed towards the threads and place the o-ring (#123-011) on top of it.

For the Low Pressure SGSM, simply place an o-ring in the o-ring groove on the bottom cell cap. The bottom cell cap does not require a seal ring.

5. Apply more high temperature grease to the seal ring and o-ring.

The o-ring should be inspected for signs of degradation before installing a new o-ring.

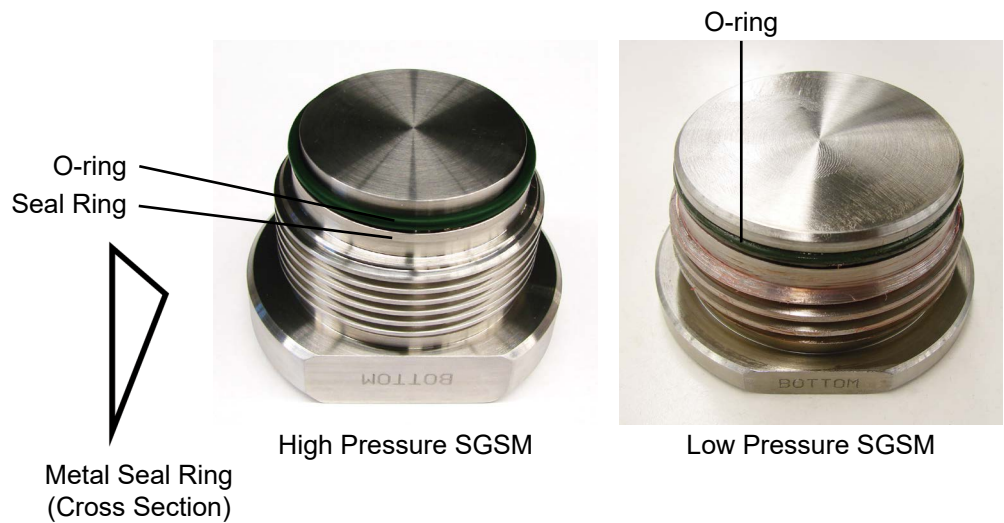

Cell assembly

The test cell is labeled to indicate which end is the top and which is the bottom. The interior of the cell has a taper with the narrow end at the top and the wider end at the bottom to facilitate cement plug removal. Apply a thin layer of high-temperature grease to the surfaces that will be in contact with cement. This will make cleaning easier when the test is complete.

1. Carefully screw the cell body onto the bottom cell cap completely. Then unscrew the cell body $\frac{1}{4}$ of a turn. This will facilitate disassembly later.



The cell body should turn smoothly onto the cell cap. If you encounter resistance, stop turning and unscrew the body slightly. Then continue turning until the cell body is completely tightened.



Watch the bottom cell cap o-ring from inside the cell body as it screws onto the cell cap. Make sure that the o-ring remains seated. If the o-ring becomes unseated, slightly unscrew the cell body and reset the o-ring to its proper location.

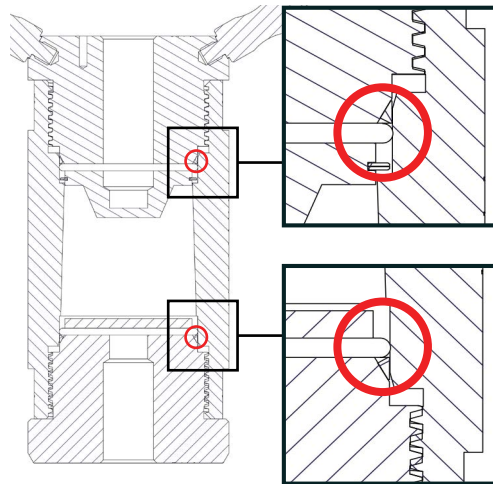

2. Remove the cell body and bottom cell cap from the vise in preparation for the top cell cap assembly.



Note

Top Cap Assembly

1. Inspect the transducer and thermocouple ports to make sure that they are clean and free of cement.
2. Install the thermocouple into one of the ports on the top cap of the SGSM test cell. Tighten the thermocouple completely then loosen it $\frac{1}{4}$ of a turn.

The two ports are interchangeable.

3. Tighten the jaws of the vice on the flats of the cell cap with the threads faced up.
4. Insert retaining ring into the lower internal ring groove of the cell cap so the gap clears the thermocouple as shown below.

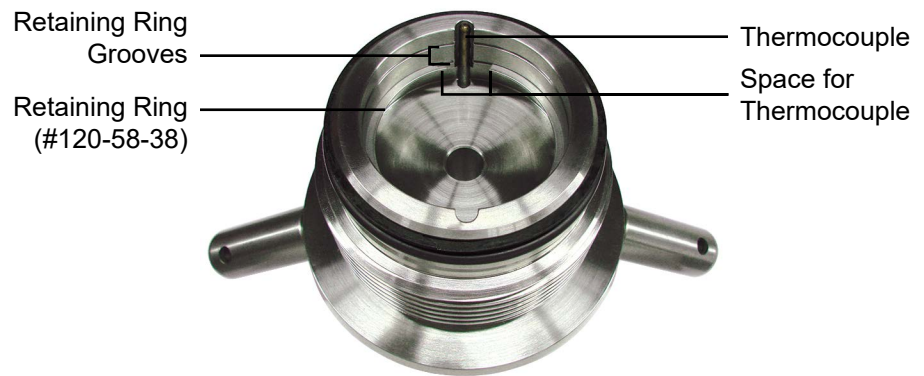

High Pressure SGSM

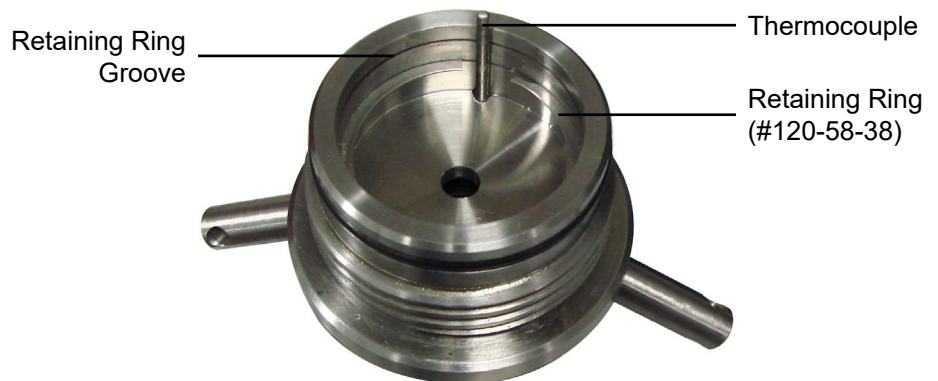

Low Pressure SGSM

5. Insert the diaphragm into the cell cap so the gap clears the thermocouple.
6. Insert the other internal retaining ring into the groove above the diaphragm so the gap clears the thermocouple as shown below.

On a High Pressure SGSM Cap, place the metal seal ring on the external portion of the cell cap with the narrow end pointed toward the threads. The seal ring should not need to be removed from the top cell cap. If it must be replaced, the metal seal ring must be reinstalled in the same orientation.



Metal Seal Ring
(Cross Section)



Note

7. Place an o-ring on the cell cap above the metal seal ring.
8. Install the external retaining ring above the o-ring.

On a Low Pressure SGSM Cap, only the o-ring (#123-011) is required externally.



Note

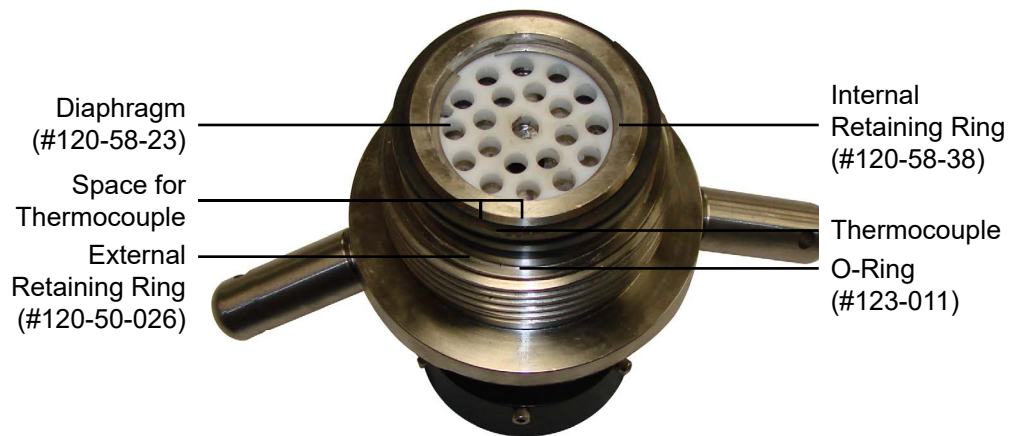

High Pressure SGSM



Low Pressure SGSM

9. Apply high temperature grease to the threads, seal ring, o-ring, and the Retaining ring.



Note

10. Install the two bushings. One bushing goes into the hole in the top of the top cell cap. The other goes inside the Mounting Adapter.

Make sure the bushings sit flush with the metal.

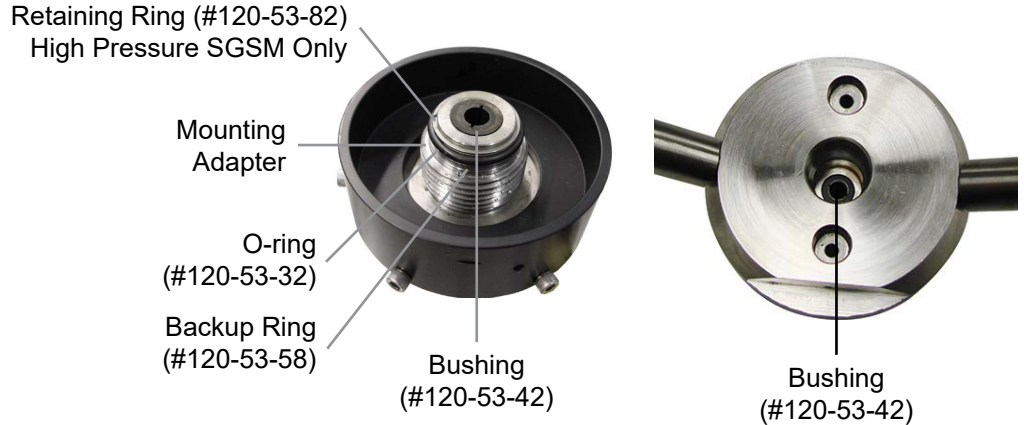

11. Secure the mounting adapter (120-58-04) with the short end facing up.

12. Place the upper backup ring (#120-53-58) around the top of the mounting adapter with the o-ring (#120-53-32) on top of it. The backup ring should be oriented with the taper pointing away from the o-ring.

13. Place a retaining ring (#120-53-82) on the mounting adapter to hold the o-ring in place.

14. Secure the mounting adapter with the longer end of the shaft pointed up. Place the lower backup ring (#120-53-59) around the bottom of the mounting adapter with the o-ring (#120-53-31) on top of it. The backup ring should be oriented with the taper pointing away from the o-ring.

15. Install the retainer ring (#120-58-05) above the o-ring.



Metal Seal Ring (Cross Section)

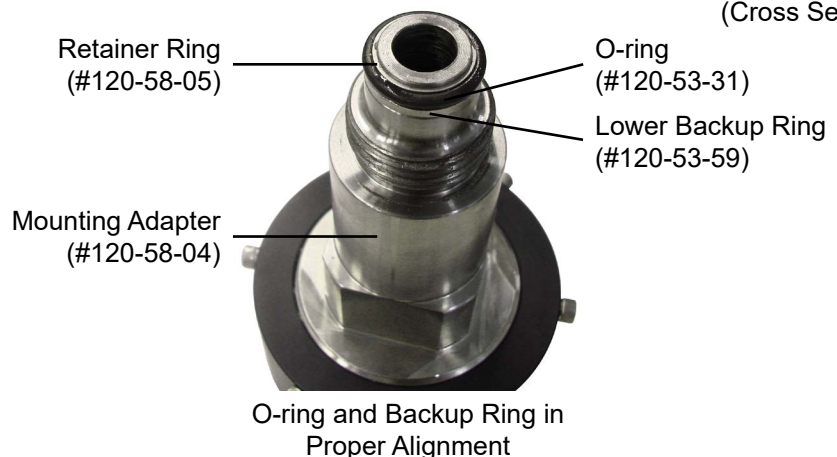

16. Install the SGSM base to the mounting adapter as shown below. Screw the threads facing inward and the allen heads on the outside of the base.
17. Insert the magnet shaft assembly (#120-58-010) into the SGSM base, threads first with the magnet facing upward.
18. Lightly grease the threads of the mounting adapter that secure the magnet cover.
19. Place the magnet cover over the magnet and screw it tight.
20. Lightly grease the threads that secure the plug and gland.
21. Install the plug and gland. Completely tighten them, then loosen them $\frac{1}{4}$ of a turn.

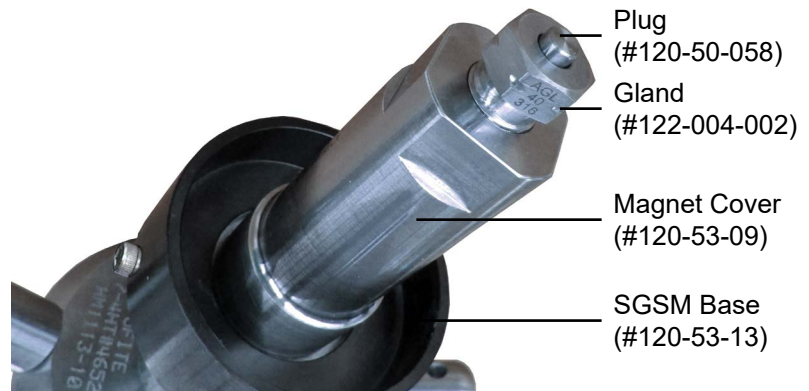

22. Secure the top cell cap in a vise with the threads facing down.
23. Carefully insert the assembled base and bob shaft through the top of the cap, with the threads of the bob shaft going in first.
24. Once the base reaches the top of the cell cap, screw the assembly onto the cell cap.

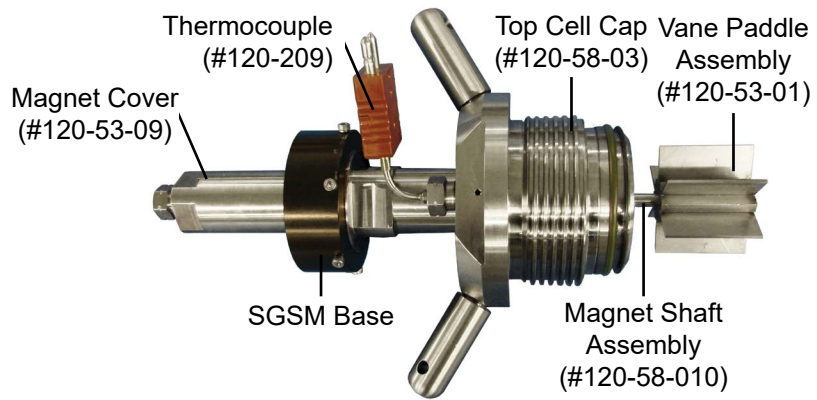

High Pressure SGSM

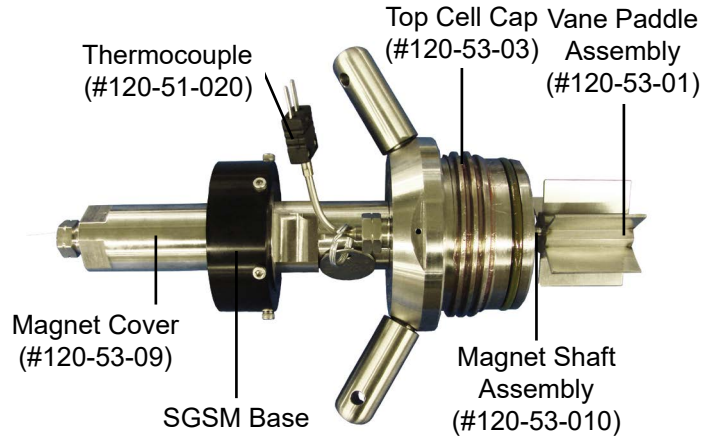

Low Pressure SGSM



Note

25. With a set of calipers, measure the diameter of the bob along all three axes of the vane. Measure the height of the bob blades in three places. Record the average diameter and average height and enter them in the Setup screen. Refer to page 8.

The bob should be measured every 3 months.

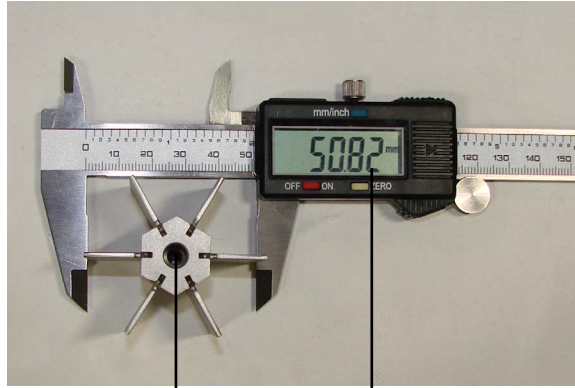

Bob

Calipers

26. Screw the bob onto the bob shaft. Hold the shaft in place with the supplied $\frac{3}{16}$ " combination wrench (#120-53-81) tightening the bob.



The bob screws counterclockwise onto the bob shaft with a left-handed thread.

Operation

SGSM Drag Check



Before running a gel strength test, it is recommended you perform a drag check in the software. Run the drag check in air.

Always perform a drag check after calibrating the transducer. During the drag check, the SGSM will run at 2RPM and the total time for the drag check will be 33sec.

1. Carefully screw the assembled SGSM top cap onto the test cell.

The cell cap should turn smoothly in the test cell threads. If you encounter resistance, stop turning and unscrew the cap slightly. Then continue turning until the cap is completely tightened.

2. Once the cap is completely tightened, unscrew it one quarter turn. This will facilitate disassembly later.
3. Install the SGSM head to the base.
4. Connect the SGSM Head to the UCA with the LPT cable. See page 7.
5. To get to the Drag Check screen in the software click Utilities→Drag Check and select “Run”.
6. Allow the test to run for 33 seconds and select “Save”.
7. Repeat the drag check test to ensure consistency.



Note

The test must have a peak drag less than 85 grams. If the value jumps wildly from one check to the next, this is an indication that there is a problem with one or more of the components of the system (bushing, shaft, load cell, etc.). You will need to inspect the SGSM assembly for problems. See page 57 for troubleshooting instructions.

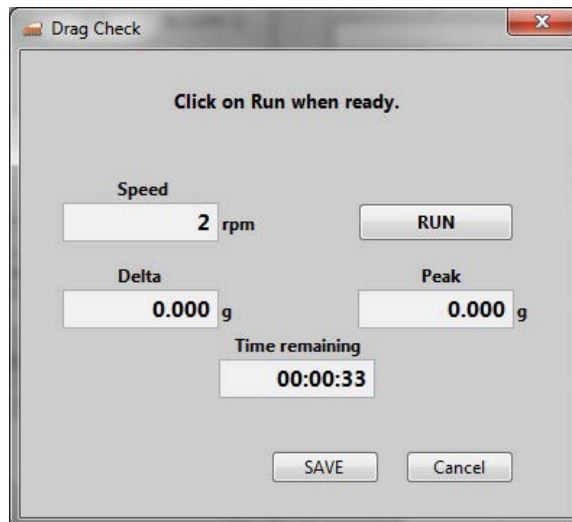

Operation

Preparing the Test Cell

Filling the Cell

1. Once the slurry has been mixed, place the fill gauge on top of the test cell.
2. Fill the cell until the cement touches the bottom of the fill gauge to the side labeled "SGSM".



Fill Gauge
(#120-51-021)

3. Carefully screw the top cell cap onto the cell body completely. The cell cap should turn smoothly onto the cell body. If you encounter resistance, stop turning and unscrew the cap slightly. Then continue turning until it tightens completely.



Tip

Unscrew the top cell cap $\frac{1}{8}$ of a turn. This will facilitate disassembly later.

Operation

Connecting the Cell

NOTE: To minimize wear and tear of the bottom acoustic transducer, remove it from the unit. It must remain paired with the top acoustic transducer.

1. Carefully place the cell into the heating jacket.
2. Align the cell as shown below.
3. Connect the water supply tube from the port on the test cell to the cabinet.
 - a. Screw the glands on the water supply tube, leaving two threads of each fitting exposed. The longer end goes to the cabinet and the shorter end goes to the cell.
 - b. Turn the cell in the heat jacket so the water supply tube is aligned properly to the cell.
 - c. Use a $\frac{5}{8}$ " wrench to tighten both glands completely.

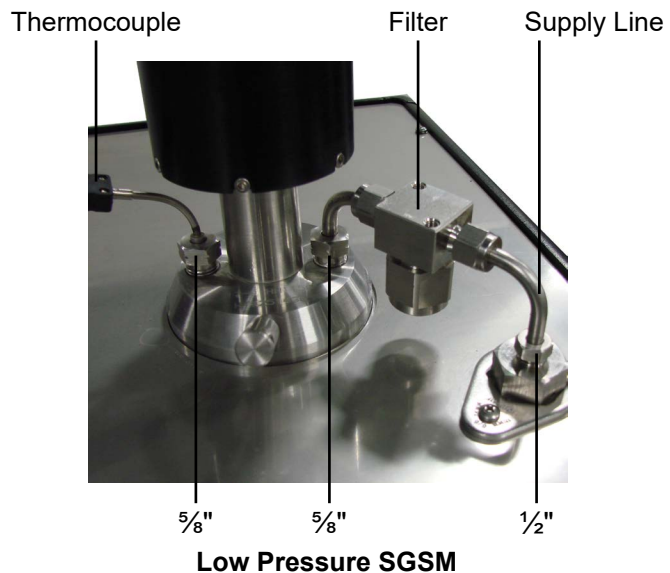
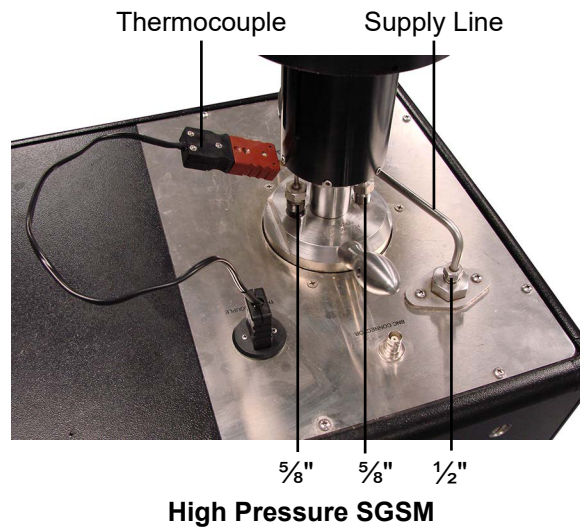

4. Plug the thermocouple from the cell cap to the port on the cabinet leaving the thermocouple gland slightly loose on the cell cap.
5. Turn the water on until water comes out of the thermocouple gland and ventilation port on the top cell cap.
 - a. On the Single Cell UCA (#120-50), turn the "WATER SUPPLY" valve to "ON".
 - b. On the Twin Cell UCA (#120-51) turn the "CELL 1 WATER" or "CELL 2 WATER" valve to "FILL".
 - c. On the Dual Cell UCA (#120-52), turn the appropriate "FILL" valve to "ON".
6. Once the water comes out of the ventilation port, tighten the thermocouple gland completely and turn the water off. This will ensure that all air has been purged from the cell.
7. Clean and dry the top cell cap and cabinet of excess water.
8. Carefully place the SGSM Drive Assembly on top of the test cell. Make sure all the cables are connected properly. See page 7 for more information.

Operation

Starting the Test

Use of this equipment in a manner not specified by the manufacturer may impair the protections provided by the equipment.

1. In the software, program a temperature profile for each test (see page 14).
2. Assemble the test cell (see page 19), load it into the heating jacket and make all the necessary connections (see page 29).
3. Pressurize the cell as described in the UCA instruction manual.
4. Click the “Start Test” button.
5. After clicking the “Start Test” button, make any changes to the test information in the information screen. Refer to page 14 for more information about the entering test information.



Note

Click “OK” to continue and start the test.

6. Turn the “Heat” Switch on.
7. When the cement reaches the gel strength specified in the “Strength #5” field on the Setup screen (see page 8), the software will automatically stop the test and turn on the alarm.



Tip

To stop the alarm on a High Pressure SGSM (#120-58), click the OK button on the alarm message in the software. The Low Pressure SGSM (#120-53) do not have a Sonalert.



Note

The alarm will not turn on until the SGSM has finished the current measurement cycle.

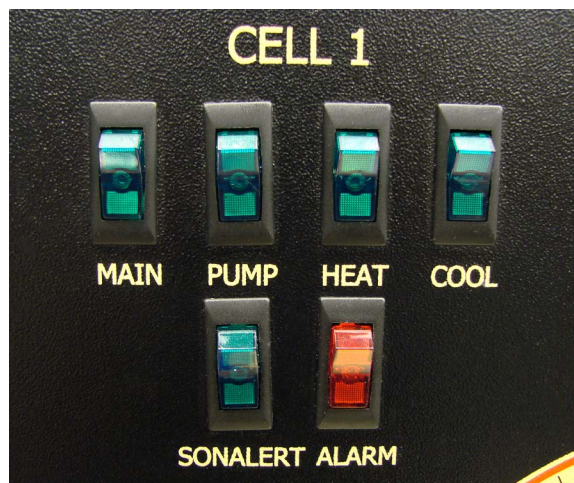

Operation

Stopping the Test

1. The test stops automatically. The alarm needs to be acknowledged and cleared by clicking the SGSM alarm (green button) that appears in the upper right hand corner.

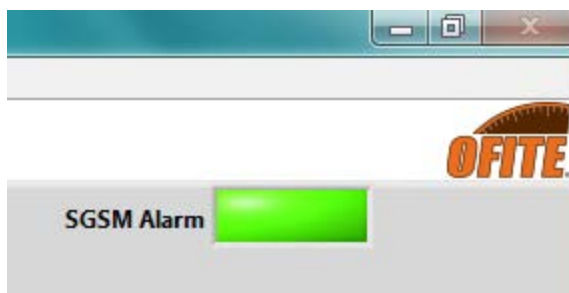

Always open the pressure release valve very slowly to prevent pulling cement into the plumbing.

2. Unscrew and remove the high-pressure line from the cell cap and the instrument cabinet.



Use caution. The test cell may contain a small amount of air at high temperature and/or pressure.

3. Unplug the thermocouple.
4. Remove the SGSM cap assembly.
5. Remove the thermocouple.
6. Lift the cell out of the heating jacket.

Operation

Evaluating Test Data

When a test is complete, the software automatically generates a .jpg file of the chart and a data file that can be opened in Excel. Both of these files will be stored in the folder specified in the “Archive Path” field on the Setup screen (see page 8 for more information).

Elap Time	Temp (°F)	Gel Strength (lb/100ft ²)	Pressure (psi)
0:17:41	89.7	13.22	5351.9
0:27:58	100.5	198.22	5380.91
0:39:04	102.8	438.22	5177.86
0:50:10	102.2	695.92	4800.76

The SGSM data file will show the elapsed test time, temperature, pressure, and gel strength at each peak during the test. This differs from the UCA data file, which includes data points at a specific time interval throughout the test.

The SGSM chart shows the temperature, pressure, and gel strength over time. The software also generates a trend line connecting the peaks of the gel strength line.

At the top of the SGSM chart are entries for “Time @ × lb/100ft²”. This shows the time at which the cement reached each gel strength.

These values are set in the Options screen (see page 8) as “Strength #1”, “Strength #2”, etc.

The “Transition Time” is the calculated time from “Strength #1” to “Strength #5”. By default, these fields are set to 100 and 500 lb/100ft² respectively.

The measurement time for the static gel strength begins once the test has completed the “Conditioning Time” entered in the setup screen. These times are interpolated based on the trend line generated from the peaks that are measured at the end of each “SGSM Test Period”.

When Multiple Conditioning is on, the Interpolated Data will only reflect data collected from the first cycle.



Note

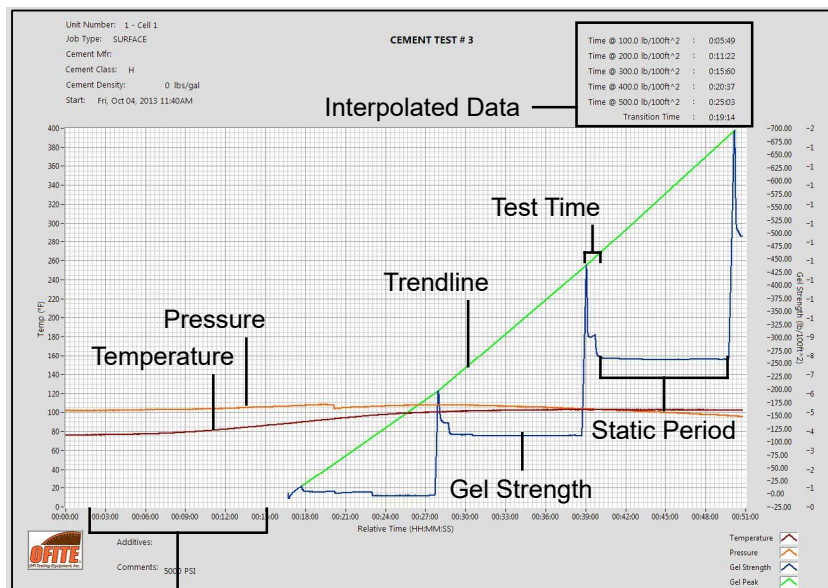

Conditioning Period

Operation

Removing the Test Cell

1. When the gel strength reaches the value in the “Gel Strength #5” field on the Options screen or the “Final Strength” field in the “Test Infos” screen, the software will automatically stop the test. The data file will be automatically saved in the folder specified on the “Setup” screen.
2. Turn the “Heat” switch off.
3. Turn the “Cool” switch on and allow the test cell to cool completely.
4. When the cell has cooled, turn the “Pump” and “Cool” switches off.
5. Turn the “Fill” valve to “OFF”.
6. Open the pressure release valve by **slowly** turning it counterclockwise.



Always open the pressure release valve very slowly to prevent pulling cement into the plumbing.

7. Disconnect the cell.
 - a. Loosen the high-pressure line on the instrument cabinet.
 - b. Unplug the thermocouple.
 - c. For SGSM tests, carefully remove the SGSM head from the test cell.
8. Lift the cell out of the heating jacket.



When removing the test cell, pay special attention to the transducer and make sure it doesn't pull off of the end of the transducer cable with the cell.



Use caution. The test cell may contain a small amount of air at high temperature and / or pressure.

Maintenance

Disassembling and Cleaning the Test Cell



Note

The test cell must be cleaned immediately after every test. Any cement left in the test cell will harden and could damage the equipment. Clean all surfaces of the test cell with soap and water.

Remove all o-rings, snap rings, and bushing and clean them individually. Carefully inspect them and discard any that show damage or wear.

If the cement sets during an SGSM test, the bob and bob shaft will set with the cement in the test cell. If this happens, it may be possible to remove bob without damaging the equipment.



Note

There are two procedures for removing the SGSM from set cement. The first procedure attempts to save the magnet and shaft. This procedure will only work if the threads on the shaft have been heavily greased. The shaft will need to twist free from the bob and any cement that has set around it.



Note

If the first procedure fails, then the second procedure will remove the magnet and shaft from the cell. However, both the magnet head and the bob shaft will be destroyed and will not be reusable. The bob itself should be reusable for further testing.



To avoid damaging the equipment, make sure all surfaces that will be in contact with the cement are covered in grease before assembling the cell.

Procedure 1:

Tools Needed:

- 10" Crescent Wrench
- $\frac{5}{8}$ " Wrench
- $\frac{1}{2}$ " Strap Wrench
- Soft Face Hammer
- Cell Cap Wrench
- Heavy Duty Vice
- Small Sledge Hammer
- Rock Chisel
- Knock Out Tool

A hardened cement plug can only be pushed out of the cell from the top to the bottom. Secure the test cell in a heavy duty vice.

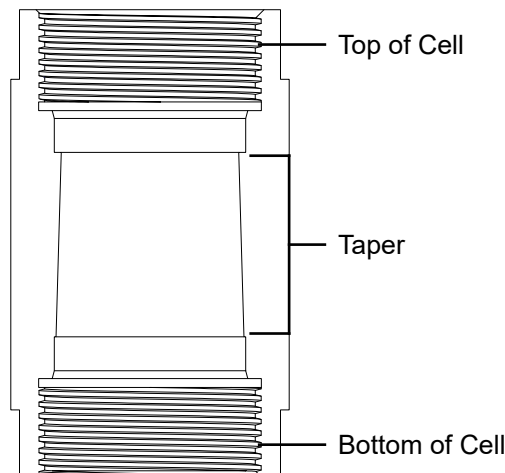

1. Tighten the jaws of the vice on the flats of the test cell with the SGSM Drive Assembly facing up.
2. Use a crescent wrench to hold the bob shaft housing in place.
3. Unscrew the black SGSM base collar.
4. Unscrew the magnetic housing on top of the cell.
5. Fit the strap wrench around the magnet on top of the shaft.



6. The bob shaft has a left-handed thread. Using the strap wrench, unscrew the shaft from the bob by rotating the shaft clockwise. The magnet is press fit onto the shaft and should move as one piece. If the magnet turns on the shaft, skip to Procedure 2.
7. When the shaft has disengaged completely from the bob, carefully remove the shaft by grasping the magnet and pulling straight up.
8. Use a $\frac{5}{8}$ " wrench to loosen the thermocouple connection and pull it straight up to make sure it pulls clear of the set cement.
9. Remove the drive adapter by unscrewing it from the cell cap with a crescent wrench.



10. Use the cell cap wrench to remove the lid of the test cell.
11. Turn the test cell over and secure it in the vice with the end labeled “BOTTOM” will be facing up.
12. Use the cell cap wrench to remove the bottom cell cap.
13. Remove the cell from the vice.
14. Set the cell upright on a counter with the end labeled “TOP” facing up.
15. Using a hammer and the knock out tool and/or a cement press, remove the cement plug from the test cell.



Tip



Note

Be sure to apply force only to the top of the cement plug.

Take extra precautions as the bob can be damaged during this operation.



16. Note the top and bottom of the cement plug. The top of the plug will have a hole in the top from which the shaft was pulled.
17. Once the cement plug has been removed, set the plug on its side.
18. Using a small chisel, begin chipping at the plug about ½” from the bottom.



Be careful not to damage the vanes on the bob.



19. Remove the cement from the bottom of the plug in small chunks until you expose one of the vanes on the bob.
20. Set the plug upside down on the counter.
21. Place the chisel next to the exposed vane and begin chipping downward away from the vane.
22. Proceed around the bob by removing the cement from between the vanes.

Procedure 2:

Tools Needed

- 10" Crescent Wrench
 - $\frac{5}{8}$ " Wrench
 - Channel Locks
 - Soft Face Hammer
 - Cell Cap Wrench
 - Heavy Duty Vice
 - Small Sledge Hammer
 - Rock Chisel
 - Knock Out Tool
1. Secure the SGSM cell in a heavy duty vice.
 2. Use a crescent wrench to hold the bob shaft housing in place.
 3. Unscrew the magnetic housing on top of the cell.
 4. Remove the magnetic housing.
 5. Use a $\frac{5}{8}$ " wrench to loosen the thermocouple connection and pull it straight up to make sure it pulls clear of the set cement.





6. Expose a section of the bob shaft:
 - a. Use a crescent wrench to unscrew the bob shaft housing.

Do not remove the housing completely!
 - b. Raise the magnetic housing enough so that you can pull the thermocouple clear.
3. Unscrew the cell cap 2 or 3 turns.
4. Screw the cell cap back down.
5. Screw the bob shaft housing back down.
6. Grip the exposed area of the shaft with a pair of channel locks.



7. The bob shaft has a left-handed thread. Loosen the shaft by turning the channel locks clockwise.
8. When the threads are fully disengaged, carefully remove the shaft.
9. Remove the magnetic housing.

The action of removing the shaft will destroy the upper bushing.
10. Use a cell cap wrench to remove the cell cap.
11. Turn the test cell over and secure it in the vice with the end labeled "BOTTOM" will be facing up.
12. Use the cell cap wrench to remove the bottom cell cap.
13. Remove the cell from the vice.
14. Set the cell upright on a counter with the end labeled "TOP" will be facing up.



Note



Tip



Note

15. Using a hammer and the knock out tool and/or a cement press, remove the cement plug from the test cell.

Be sure to apply force only to the top of the cement plug.

Take extra precautions as the bob can be damaged during this operation.



16. Note the top and bottom of the cement plug. The top of the plug will have a hole in the top from which the shaft was pulled.

17. Set the plug on its side.

18. Using a small chisel, begin chipping at the plug about 1/2" from the bottom.

19. Remove the cement from the bottom of the plug in small chunks until you expose one of the vanes on the bob.



20. Set the plug upside down on the counter.

21. Place the chisel next to the exposed vane and begin chipping downward away from the vane.

22. Proceed around the bob by removing the cement from between the vanes.

Do not use any type of decontamination or cleaning agents as they may cause a hazard as a result of a reaction with parts of the equipment or with material contained within. If there is any doubt about the compatibility of a decontamination or cleaning agent please contact OFITE Technical Support.



Maintenance

Changing a Fuse



If the SGSM Electronics Box does not power on, check the fuse.

1. Unplug the power cord leading to the SGSM Electronics Box.
2. Remove the fuse holder next to the power receptacle.
3. If either fuse is blown, replace it with a new one.

The SGSM Electronics Box uses two 2 amp fuses.

4. Put the fuse holder back into the slot.
5. Plug the power cord back in.
6. Turn on the Electronics Box to ensure it is working again.

ALWAYS connect the SGSM head before powering up the electronics box. NEVER plug in the SGSM head when the box is already on. This could damage the SGSM board.

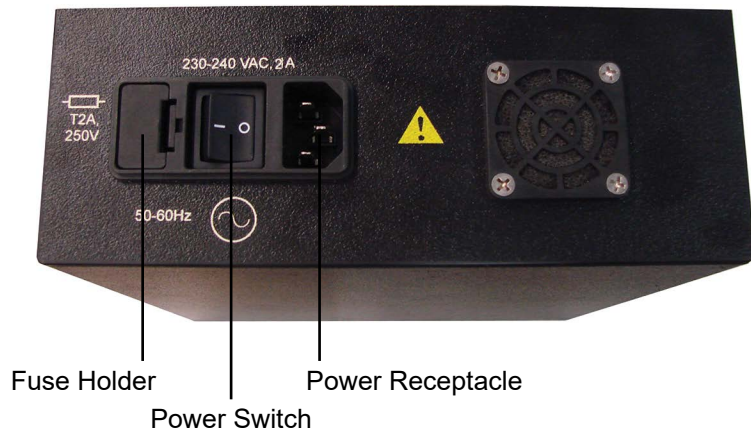

Appendix

Filling The Cell

This section applies to earlier models of the UCA.

1. Place the bottom cell cap in a vice with the threads facing upward.
2. Carefully screw the cell body onto the bottom cell cap completely. Then unscrew the cell body $\frac{1}{4}$ of a turn. This will facilitate disassembly later.
3. Begin filling with the cement slurry. Place the fill gauge on top of the test cell. Fill the cell until the cement touches the bottom of the fill gauge.

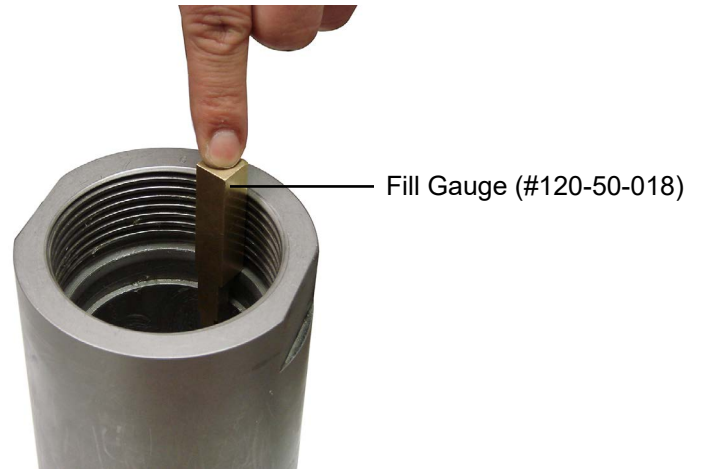

High Pressure SGSM



Low Pressure SGSM

4. Carefully screw the top cell cap into the test cell, just as you did with the bottom cell cap.

Appendix *Magnet Positioning*

This section applies to earlier models of the SGSM.

It may be necessary to reposition the magnet in the SGSM Drive Assembly.

1. Remove the Drive Assembly from the test cell.
2. Turn the Drive Assembly upside down.
3. Unscrew the support.
4. Locate the set screw that holds the magnet on the bob shaft. Loosen the set screw enough for the magnet to move freely.
5. Adjust the magnet so that the top is 3.16 inches from the base of the Drive Assembly. Use calipers to measure the distance.
6. When the magnet is in position, tighten the set screw to hold it in place.
7. Screw the support back onto the base of the Drive Assembly.



Appendix

Calibration - Old Style

This section applies to earlier models of the SGSM.

The transducer on the SGSM should be calibrated periodically to ensure accurate readings. The calibration is performed with a dead-weight set.

1. Remove the transducer from the SGSM and place it on one of the slotted weights.



Transducer



Weight

2. Make sure the SGSM is connected to the computer and that the software is running.
3. Select "Calibrate SGSM" from the "Utilities" menu.
4. You will be prompted to take a reading with no weight on the transducer. Simply click the "Accept" button.

5. You will now be prompted to add weight to the transducer. Place the appropriate weight on the transducer and click the "Accept" button.

The first time the unit is calibrated, the software will not tell you what weights to use. The correct weights are: 0g, 100g, 200g, and 400g.

6. Continue adding weight according to the prompts and click "Accept" every time.
7. When the calibration is complete, click the "Save" button.
8. Reinstall the transducer onto the SGSM.

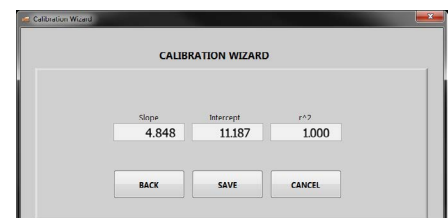
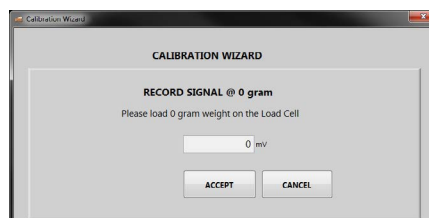

Appendix

SGSM Cell Cap Assembly

This section applies to earlier models of the SGSM.

1. Screw the thermocouple into one of the ports on the top cap of the SGSM test cell.

The two ports are interchangeable.

2. Insert a retaining ring into the upper groove on the inside of the cell cap.

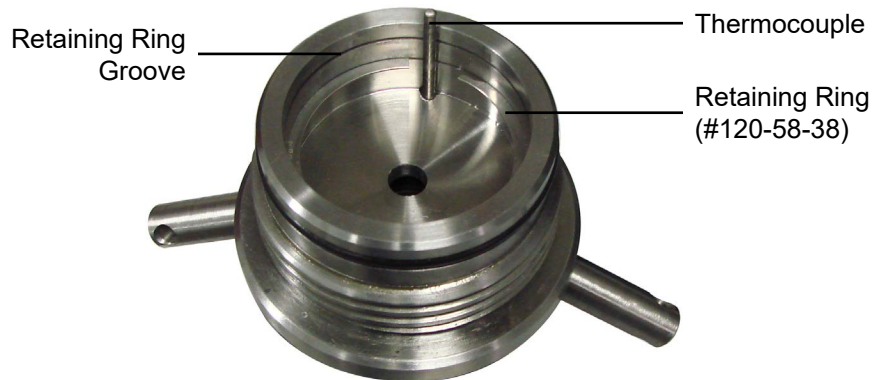

3. Insert the diaphragm into the cell cap.

4. Insert the other retaining ring into the groove below the diaphragm.



5. Place an o-ring on the cell cap.

6. Install the two bushings. One bushing goes into the hole in the top of the top cell cap. The other goes inside the Mounting Adapter.

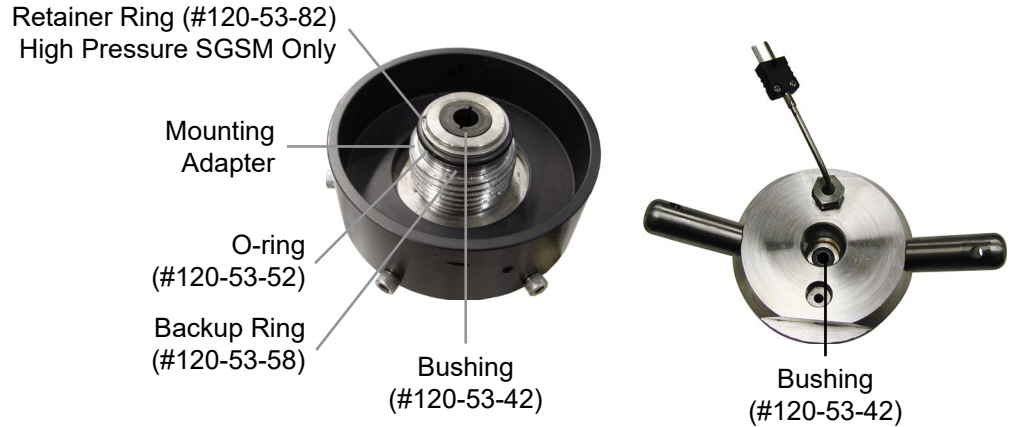

7. Place the upper backup ring (#120-53-58) around the top of the Mounting Adapter with the o-ring (#120-53-32) on top of it. The backup ring should be oriented with the taper pointing toward the o-ring.
8. Slide the bob shaft into the SGSM base.
9. Place the magnet cover over the magnets and screw it tight.

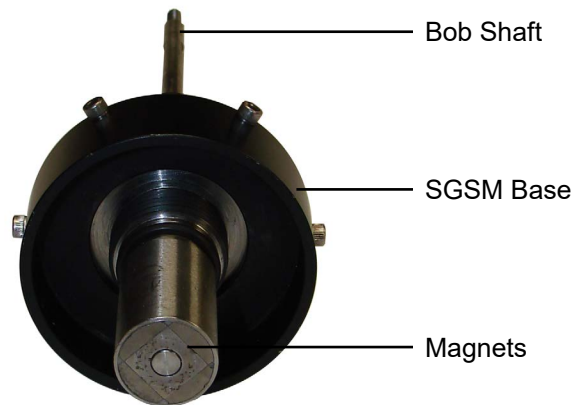

10. Hold the SGSM base with the threaded end of the shaft pointed up. Place the lower backup ring (#120-53-59) around the bottom of the Mounting Adapter with the o-ring (#120-53-31) on top of it. The backup ring should be oriented with the taper pointing toward the o-ring. Make sure the backup ring and o-ring are centered around the Mounting Adapter.

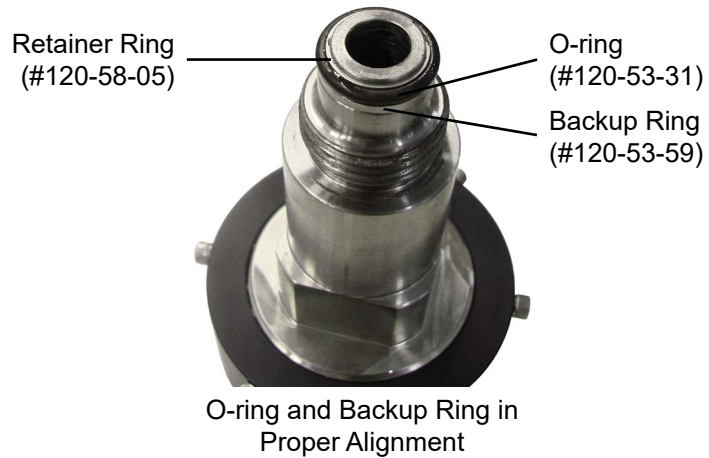

11. Carefully lower the cell cap onto the shaft, making sure the backup ring and o-ring remain in proper alignment. Screw the two pieces together hand tight.

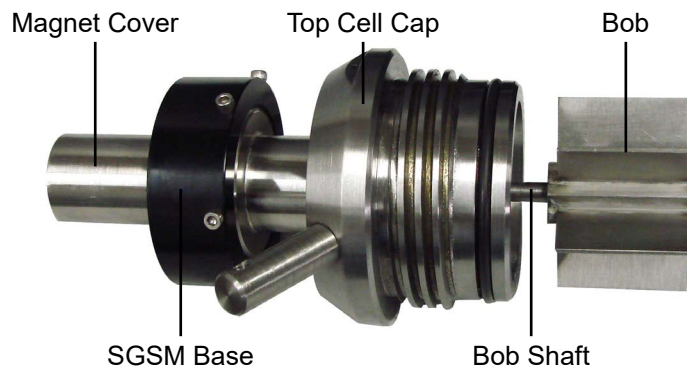



12. With a set of calipers, measure the diameter of the bob along all three axes of the vane. Measure the height of the bob blades in three places. Record the average diameter and average height and enter them in the Setup screen. Refer to page 8.

The bob should be measured every 3 months.

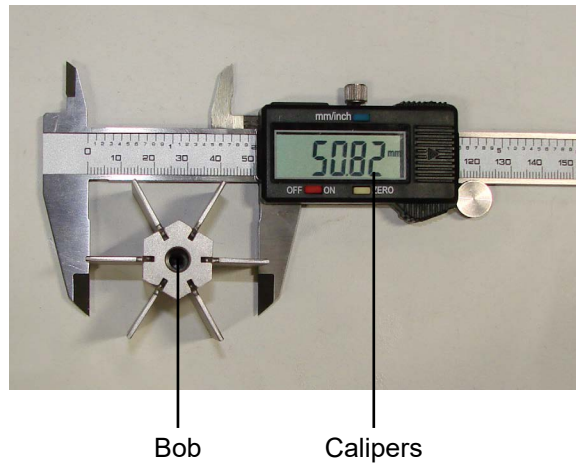

13. Screw the bob onto the bob shaft. Hold the shaft in place with a $\frac{3}{16}$ " combination wrench (#120-53-81, supplied) or needle-nose pliers while tightening the bob.



The bob screws counterclockwise onto the bob shaft with a left-handed thread.

14. Place an o-ring in the o-ring groove on the cell cap.



Bottom Cell Cap

Appendix

Calibration - New Style

The transducer on the SGSM should be calibrated periodically to ensure accurate readings. The calibration is performed with a dead-weight set.

1. Remove the torque spring from the SGSM and install the calibration pulley.
2. Connect the wire to the torque spring post and thread it over the calibration pulley.

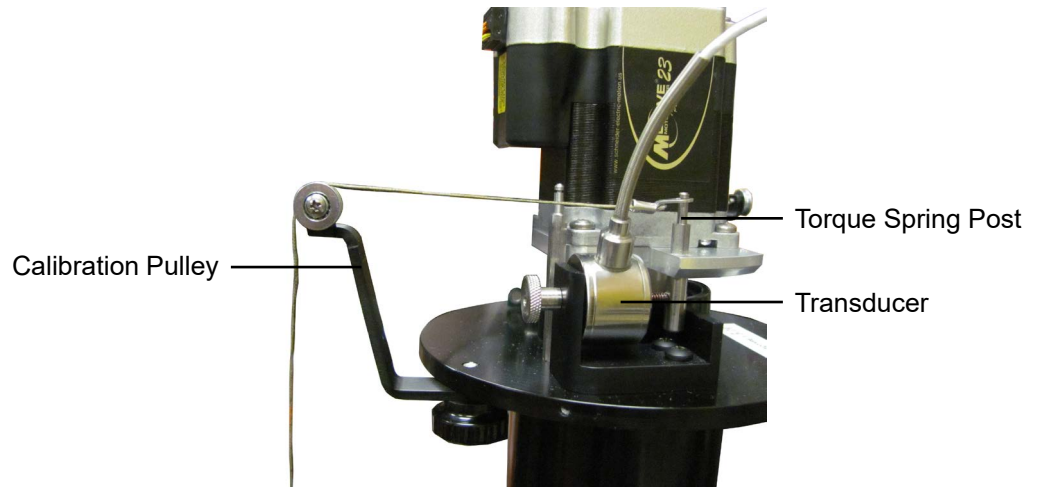

3. Attach the other end of the wire to the hook on the calibration dead-weight holder. Adjust the SGSM so that the weight holder is hanging freely.

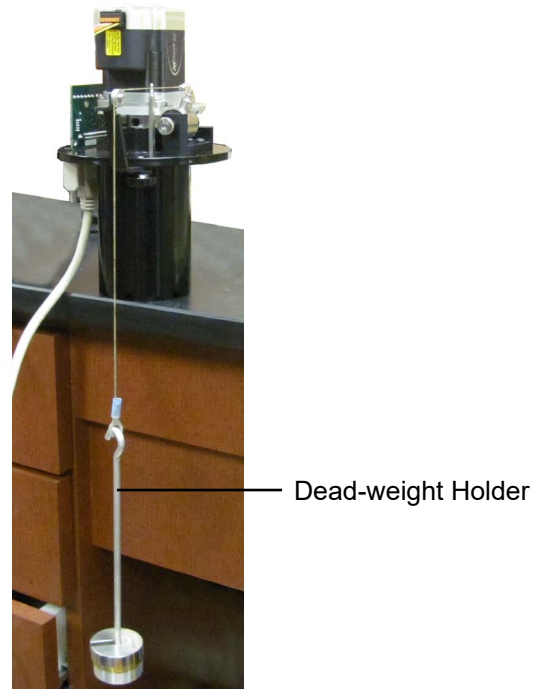

4. Make sure the SGSM is connected to the computer and that the software is running (see page 7).
5. Click Utilities → Calibrate Load Cell (For Single SGSM).
Cell 1/Cell 2 → Calibrate Load Cell (For Dual SGSM).
6. You will be prompted to take a reading with no weight on the transducer. Simply click the “Accept” button.
7. You will now be prompted to add weight to the weight holder. Place the appropriate weight on the holder and click the “Accept” button.



Tip

When calibrating the unit for the first time, the software does not provide prompts that indicate which weights to apply to the weight holder. The correct weights are: 0g, 100g, 200g, and 400g.

8. Continue adding weight according to the prompts and click “Accept” every time.
9. When the calibration is complete, click the “Save” button.
10. Remove the calibration pulley assembly and reinstall the tension spring between the base spring post and the torque spring post.

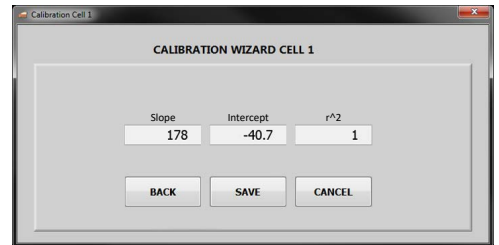
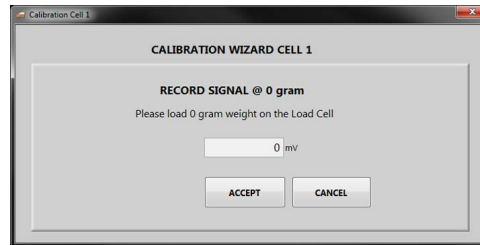

Appendix

Maintenance Schedule

Procedure	Schedule
Calibrate Transducer	<ul style="list-style-type: none">- After any mechanical components are changed (bob, shaft, bushings, transducer, etc)- Monthly
Replace Bushings	<ul style="list-style-type: none">- If the bushings show signs of damage or wear- When the SGSM Drag Check results are too high (see page 27)
SGSM Drag Check	<ul style="list-style-type: none">- Before every test
Bob Measurements	<ul style="list-style-type: none">- Every 3 Months
Fuses	<ul style="list-style-type: none">- As needed (see page 41)

Appendix

Multiple Instruments

It is possible to control multiple SGSMS from a single computer. To setup the software for multiple SGSMS, repeat the following procedure for each instrument.

1. Plug each instrument into a separate serial port on the computer.
2. On the computer, navigate to the “C:\Program Files (x86)” folder.
3. Locate the “SGSM” folder and select it.
4. Hold down the CTRL key and then press C. Then hold down the CTRL key and hit V. This will create a duplicate of the folder called “SGSM - Copy”.
5. Choose a name to identify the new instrument.
6. Rename the new folder with the name of the instrument.
7. Locate the program file (.exe) inside the folder and rename it with the name of the instrument.



Tip

For convenience, create a shortcut to this file on the desktop.

8. Open the software using the new program file.
9. Change the “Archive Path” to a new folder. See page 8 for instructions.



Note

Each instrument must have its own Archive Path.

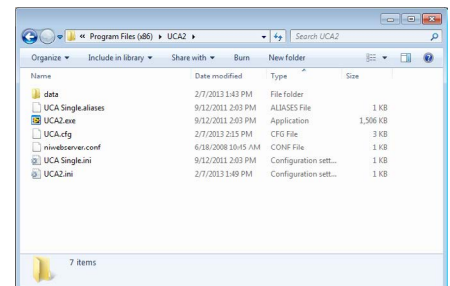
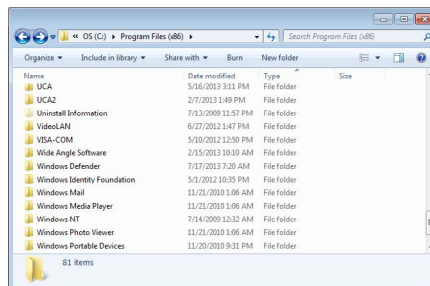

Appendix

Manual Temperature Control

The Eurotherm temperature controller allows the user to program a temperature profile manually. The Eurotherm is in manual mode by default but will change to auto mode when the test begins. The user must change it to manual mode after the test has started.

This profile will be divided into at least two segments. Each segment represents either a change in temperature or a period of time to hold the current temperature.

The four buttons along the bottom of the display provide access to the temperature controller parameters. To program a test:

1. Press the "PAGE" button until the display reads "Prog List".
2. Press the "SCROLL" key to select the parameter you want to change.
3. Press either arrow key to set the value for the parameter.
4. Repeat steps 2 and 3 until all parameters are set.



The PID and other internal settings have been optimized for this instrument. Do not change anything other than program parameters.

For more information, refer to the Eurotherm instruction manual.

The first group of parameters will be the same for every test. Do not change them:

<u>Parameter</u>	<u>Value</u>
Prg1	1
Hb	OFF
Hb.u	0.0
Rmp.u	min
Dwl.u	min
Cyc.n	1

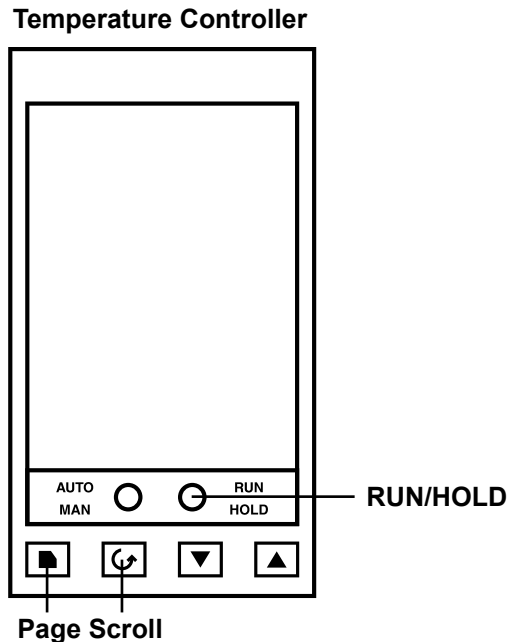

1. Begin by defining the first segment of the test.
 - a. Press the “SCROLL” key until “Seg” appears on the display.
 - b. Press either arrow key to select “1” (segment 1).
2. The first parameter is “Type”.
 - a. Press the “SCROLL” key to select “Type”.
 - b. The available options are “rmp.r”, “rmp.t”, or “dwell”. Press either arrow key to select one.

Rmp.r programs the controller to steadily increase the temperature by a specified rate (degrees per minute). If you choose this option, the next parameter will be “Tgt” (target temperature) and then “Rate”

Rmp.t increases the temperature over a specified time interval (minutes). If you choose this option, the next parameter will be “Tgt” (target temperature) and then “Dur” (duration in minutes).

Dwell holds the temperature at its current set point for a specified length of time. If you choose this option, the next parameter will be “Dur” (duration in minutes).

- c. Press the “SCROLL” key to select the remaining parameters (target temperature, rate, or duration).
 - d. Press either arrow key to select the options for each parameter.
3. Now define the second segment.
 - a. Press the “SCROLL” key until “Seg” appears on the display.
 - b. Press either arrow key to select “2” (segment 2).
4. Continue this process with each segment in the test.
5. When you reach the last segment, set the “Type” to “end”. The next parameter will be “End.t”.

If you choose “**sop**”, the heat will be turned off and the test ended.

If you choose “**dwell**”, the heat will be held at the current temperature indefinitely.

Example 1:

Heat the sample at 2.5° per minute and stop at 150°. Hold at 150° for 180 minutes and then stop the heat.

<u>Parameter</u>	<u>Value</u>	<u>Description</u>
Prg	1	} Do not change
Hb	OFF	
Hb.u	0.0	
Rmp.u	min	
Dwl.u	min	
Cyc.n	1	
Seg	1	Segment 1
Type	rmp.r	Increase temperature at a specified rate
Tgt	150	Heat to 150°
Rate	2.5	Increase temperature at 2.5° per minute
Seg	2	Segment 2
Type	dwll	Hold on the current temperature
Dur	180	Hold for 180 minutes
Seg	3	Segment 3
Type	end	This is the last segment
End.t	sop	Stop the heat

Example 2:

Heat the sample to 200° over a period of 90 minutes. Then increase the temperature to 300° at a rate of 3° per minute. Hold that temperature until the unit is turned off.

Prg	1	} Do not change
Hb	OFF	
Hb.u	0.0	
Rmp.u	min	
Dwl.u	min	
Cyc.n	1	
Seg	1	Segment 1
Type	rmp.t	Increase temperature for a specified time
Tgt	200	Heat to 200°
Dur	90	Increase temperature for 90 minutes
Seg	2	Segment 2
Type	rmp.r	Increase temperature at a specified rate
Tgt	300	Heat to 300°
Rate	3	Increase temperature at 3° per minute
Seg	3	Segment 3
Type	end	This is the last segment
End.t	dwll	Hold at the current temperature indefinitely

Appendix

Electrical System Grounding

Proper grounding protects the equipment operator from the risk of electric shock. The electrical cord provided with this equipment has an equipment grounding conductor and a grounding plug. Observe the following guidelines at all times:

- Always connect the plug to a matching outlet that is properly installed and grounded.
- If an extension cord is necessary, make sure it has three prongs and is compatible with the electrical cord provided with the equipment.
- Do not modify the electrical cord provided with the equipment. If it is not compatible with any available outlets, have a compatible outlet installed by a qualified electrician.
- If the equipment-grounding conductor (solid green or green and yellow) is improperly connected, the operator will be at risk of electrical shock. Never connect it to a live terminal.
- Local codes may require a Ground Fault Circuit Interrupter (GFCI).
- Repair or replace a damaged or worn cord immediately.
- When in doubt, consult a qualified electrician.

Appendix

Troubleshooting

Symptom	Cause	Remedy
Power		
There is no power to the machine	The main power cord is not plugged in.	Ensure the power cord(s) is firmly into the wall and the machine
	One of the fuses for the main power supply is blown	Check and replace the fuses, see page 41.
Thermocouple		
Thermocouple will not fit into the cell cap	The port is filled with cement.	Use a small drill bit to clear the cement blockage.
	The thermocouple is bent.	Replace the thermocouple
	The hub collar is too low on the thermocouple shaft	Screw the collar up until there are 2 threads showing.
Software		
Trace lines are missing from the graph	The boxes for each line are unchecked	Check the appropriate boxes
Drag Check		
If the Peak Values are not consistent between tests with just the Head Assembly versus test in water	Transducer is out of calibration (only for #120-58 - High Pressure, 20,000 PSI SGSM)	First, calibrate the transducer (see page 49).
	The cell cap is bent	Disassemble the SGSM cell cap and make sure the cap is not bent.
	Bushings may be damaged or worn	Inspect the bushings for damage or wear. Replace any damaged or worn components and run the drag check again.

Appendix

Diagrams - Drive Assembly

#120-58-005 - Drive Assembly - For High Pressure and Low Pressure SGSM

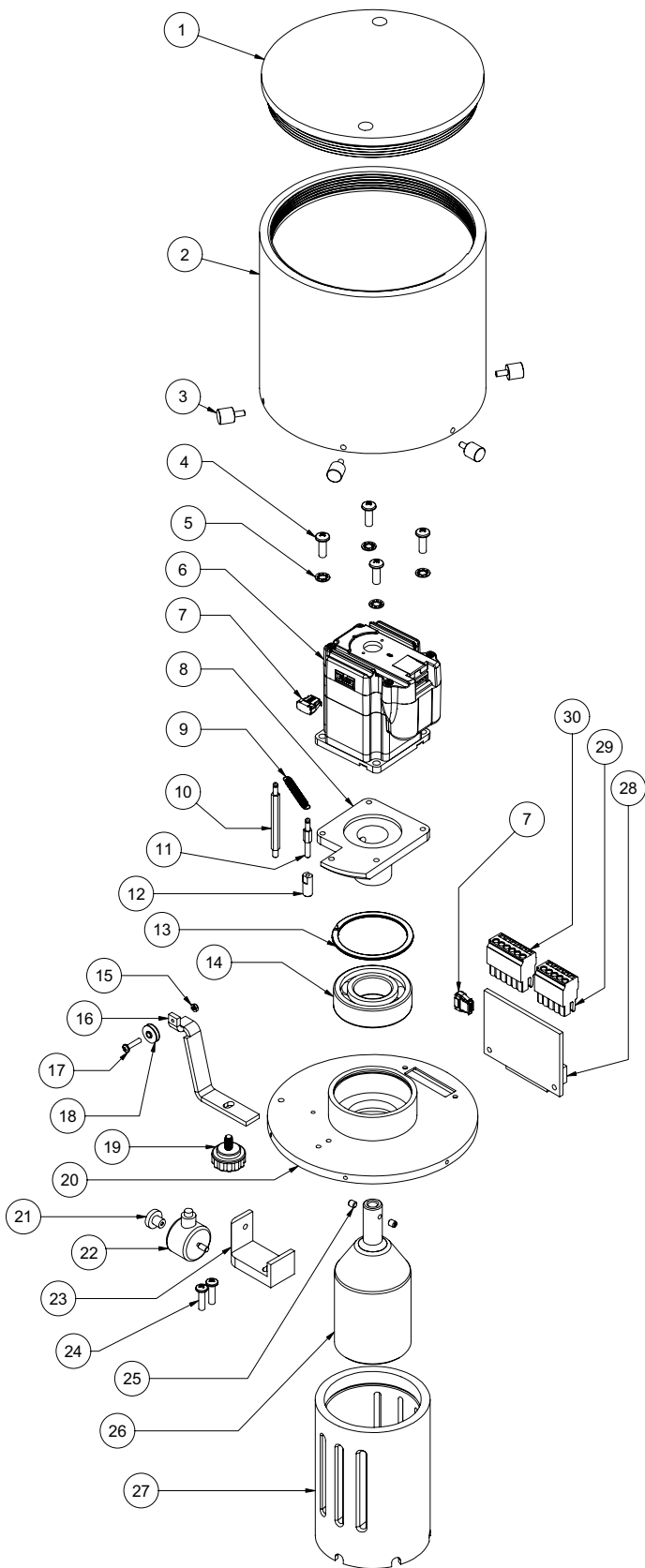

- | | | |
|-----|------------|------------------------------------------------|
| 1. | 120-53-16 | Cap for Drive Cover |
| 2. | 120-53-15 | Body for Drive Cover |
| 3. | 120-53-57 | Thumb Screw, 6-32 × .375"L, Qty: 6 |
| 4. | | Screw, Pan Head, 10-32 × .75"L, Qty: 4 |
| 5. | | Lock Washer, Qty: 4 |
| 6. | 130-76-28 | Motor |
| 7. | 120-53-37 | Connector, Motor to Board, 10 Position, Qty: 2 |
| 8. | 120-53-20 | Flange for Motor Mount |
| 9. | 120-53-33 | Spring for Load Cell |
| 10. | 120-53-22 | Post for Torque Spring, Tall |
| 11. | 120-53-21 | Post for Torque Spring, Short |
| 12. | 120-53-17 | Post for Torque Transducer |
| 13. | 120-53-60 | Retaining Ring, Internal |
| 14. | 120-53-041 | Bearing |
| 15. | | Nut, 4-40, 3/16"W × 1/16"H |
| 16. | 120-58-08 | Calibration Stand |
| 17. | 120-610 | Screw, Phillips, Pan Head, 4-40 × .375"L |
| 18. | 120-58-11 | Pulley for Calibration Stand |
| 19. | 120-58-10 | Thumb Screw, 10-32 × 3/8"L |
| 20. | 120-53-11 | Drive Base |
| 21. | 120-53-55 | Thumb Screw for Load Cell, 6-32 × 1/2"L |
| 22. | 120-53-34 | Load Cell |
| 23. | 120-53-18 | Mount for Torque Transducer |
| 24. | | Screw, Pan Head, #8-32 × 9/16" LG, Qty: 2 |
| 25. | | Set Screw, Hex, Flat Pt, 8-32 × 3/16", Qty: 2 |
| 26. | 120-53-02 | Magnet for Driver Assembly |
| 27. | 120-58-14 | Support for Drive Assembly |
| 28. | 120-53-75 | A/D Board Assembly |
| 29. | 120-53-29 | Connector for Load Cell, 5 Pin |
| 30. | 120-53-30 | Connector for Motor, 6 Pin |

Appendix

Diagrams - High Pressure Cell Assembly

#120-58-006 - Cell Assembly for High Pressure SGSM

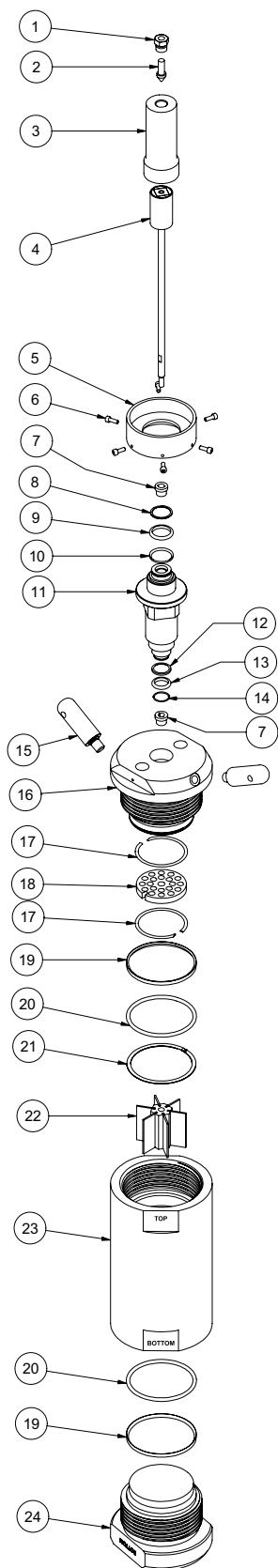

- | | | |
|-----|--------------|------------------------------------------------|
| 1. | 120-51-024 | Gland, Medium Pressure |
| 2. | 120-51-024-1 | Plug, Medium Pressure |
| 3. | 120-53-09 | Cover for Driven Magnet |
| 4. | 120-58-010 | Magnet Shaft Assembly |
| 5. | 120-53-13 | Base Flange |
| 6. | | Screw, Hex Head Cap, #6-32 x 3/8" Long, Qty: 6 |
| 7. | 120-53-42 | Bushing, Qty: 2 |
| 8. | 120-53-82 | Retaining Ring, External |
| 9. | 120-53-32 | O-ring |
| 10. | 120-53-58 | Backup Ring, Upper |
| 11. | 120-58-04 | Mounting Adapter |
| 12. | 120-53-59 | Backup Ring, Lower |
| 13. | 120-53-31 | O-ring |
| 14. | 120-58-05 | Retaining Ring |
| 15. | 120-51-4 | Handle, Qty: 2 |
| 16. | 120-58-03 | Cell Cap |
| 17. | 120-58-38 | Retaining Ring, Internal, Qty: 2 |
| 18. | 120-58-23 | Diaphragm |
| 19. | 120-50-027-1 | Seal Ring, Qty: 2 |
| 20. | 123-011 | O-ring, Qty: 2 |
| 21. | 120-50-026 | Retaining Ring, External |
| 22. | 120-53-01 | Vane Paddle Assembly |
| 23. | 120-50-021A | Cell Body |
| 24. | 120-50-021B | Bottom Cap |

Appendix

Diagrams - Low Pressure Cell Assembly

#120-53-006 - Cell Assembly for Low Pressure SGSM

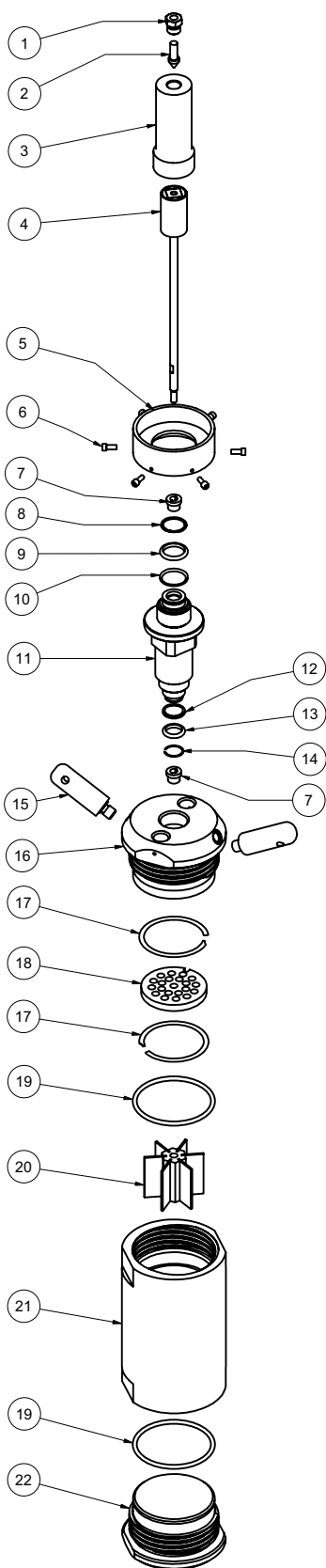

- | | | |
|-----|--------------|---------------------------------------------------|
| 1. | 120-51-024 | Gland, Medium Pressure |
| 2. | 120-51-024-1 | Plug, Medium Pressure |
| 3. | 120-53-09 | Cover for Driven Magnet |
| 4. | 120-53-010 | Magnet Shaft Assembly |
| 5. | 120-53-13 | Base Flange |
| 6. | | Screw, Hex Head Cap, #6-32 × 3/8"
Long, Qty: 6 |
| 7. | 120-53-42 | Bushing, Qty: 2 |
| 8. | 120-53-82 | Retaining Ring, External |
| 9. | 120-53-32 | O-ring |
| 10. | 120-53-58 | Backup Ring, Upper |
| 11. | 120-58-04 | Mounting Adapter |
| 12. | 120-53-59 | Backup Ring, Lower |
| 13. | 120-53-31 | O-ring |
| 14. | 120-58-05 | Retaining Ring |
| 15. | 120-51-4 | Handle, Qty: 2 |
| 16. | 120-53-03 | Cell Cap |
| 17. | 120-53-38 | Retaining Ring, Internal, Qty: 2 |
| 18. | 120-53-23 | Diaphragm |
| 19. | 123-011 | O-ring, Qty: 2 |
| 20. | 120-53-01 | Vane Paddle Assembly |
| 21. | 120-51-1 | Cell Body |
| 22. | 120-51-2 | Bottom Cap |

Warranty and Return Policy

Warranty:

OFI Testing Equipment, Inc. (OFITE) warrants that the products shall be free from liens and defects in title, and shall conform in all respects to the terms of the sales order and the specifications applicable to the products. All products shall be furnished subject to OFITE's standard manufacturing variations and practices. Unless the warranty period is otherwise extended in writing, the following warranty shall apply: if, at any time prior to twelve (12) months from the date of invoice, the products, or any part thereof, do not conform to these warranties or to the specifications applicable thereto, and OFITE is so notified in writing upon discovery, OFITE shall promptly repair or replace the defective products. Notwithstanding the foregoing, OFITE's warranty obligations shall not extend to any use by the buyer of the products in conditions more severe than OFITE's recommendations, nor to any defects which were visually observable by the buyer but which are not promptly brought to OFITE's attention.

In the event that the buyer has purchased installation and commissioning services on applicable products, the above warranty shall extend for an additional period of twelve (12) months from the date of the original warranty expiration for such products.

In the event that OFITE is requested to provide customized research and development for the buyer, OFITE shall use its best efforts but makes no guarantees to the buyer that any products will be provided.

OFITE makes no other warranties or guarantees to the buyer, either express or implied, and the warranties provided in this clause shall be exclusive of any other warranties including ANY IMPLIED OR STATUTORY WARRANTIES OF FITNESS FOR PURPOSE, MERCHANTABILITY, AND OTHER STATUTORY REMEDIES WHICH ARE WAIVED.

This limited warranty does not cover any losses or damages that occur as a result of:

- Improper installation or maintenance of the products
- Misuse
- Neglect
- Adjustment by non-authorized sources
- Improper environment
- Excessive or inadequate heating or air conditioning or electrical power failures, surges, or other irregularities
- Equipment, products, or material not manufactured by OFITE
- Firmware or hardware that have been modified or altered by a third party
- Consumable parts (bearings, accessories, etc.)

Returns and Repairs:

Items being returned must be carefully packaged to prevent damage in shipment and insured against possible damage or loss. OFITE will not be responsible for equipment damaged due to insufficient packaging.

Any non-defective items returned to OFITE within ninety (90) days of invoice are subject to a 15% restocking fee. Items returned must be received by OFITE in original condition for it to be accepted. Reagents and special order items will not be accepted for return or refund.

OFITE employs experienced personnel to service and repair equipment manufactured by us, as well as other companies. To help expedite the repair process, please include a repair form with all equipment sent to OFITE for repair. Be sure to include your name, company name, phone number, email address, detailed description of work to be done, purchase order number, and a shipping address for returning the equipment. All repairs performed as "repair as needed" are subject to the ninety (90) day limited warranty. All "Certified Repairs" are subject to the twelve (12) month limited warranty.

Returns and potential warranty repairs require a Return Material Authorization (RMA) number. An RMA form is available from your sales or service representative.

Please ship all equipment (with the RMA number for returns or warranty repairs) to the following address:

OFI Testing Equipment, Inc.
Attn: Repair Department
11302 Steeplecrest Dr.
Houston, TX 77065
USA

OFITE also offers competitive service contracts for repairing and/or maintaining your lab equipment, including equipment from other manufacturers. For more information about our technical support and repair services, please contact techservice@ofite.com.